



[www.HYTECHGROUP.com](http://www.HYTECHGROUP.com)

World class

Hydraulic Fittings, Cylinders, Hoses & Precision Components

ISO 9001-2008 Company



## CONVERSION FITTINGS

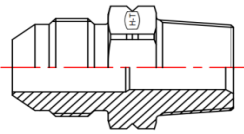

MJ-MBSPT Straight

[HT7000-00-00](#)

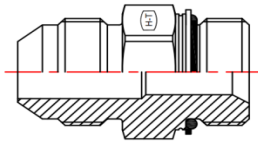

MJ-MM Straight

[HT7001-00-00](#)

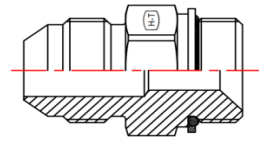

MJ-MBSPP Straight

[HT7002-00-00-ORR](#)

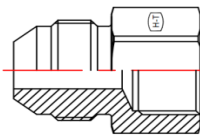

MJ-FBSPP Straight

[HT7003-00-00](#)

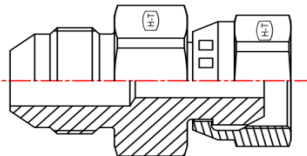

MJ-FBSPS Straight

[HT7004-00-00](#)

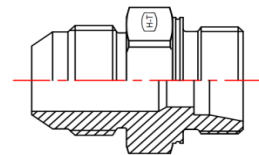

MJ-MM Dual Purpose (L)

[HT7005-L-00-00](#)

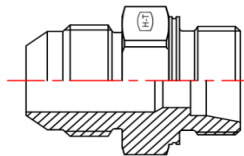

MJ-MM Dual Purpose (S)

[HT7005-S-00-00](#)

**DRAWINGS ARE  
UNDER  
DEVELOPMENT**

[HT7007-L-00-00](#)

**DRAWINGS ARE  
UNDER  
DEVELOPMENT**

[HT7007-S-00-00](#)

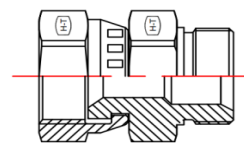

FJS-MBSPP STRAIGHT

[HT7022-00-00](#)

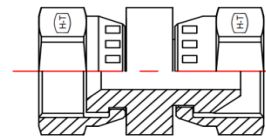

FJS-FBSPPS Straight

[HT7023-00-00](#)

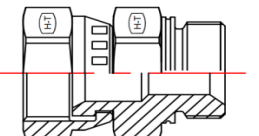

FJS-MM Straight

[HT7025-00-00](#)



[www.HYTECHGROUP.com](http://www.HYTECHGROUP.com)

World class

Hydraulic Fittings, Cylinders, Hoses & Precision Components

ISO 9001-2008 Company



## CONVERSION FITTINGS

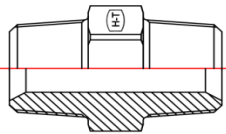

**MP-MBSPT Straight**

[HT7030-00-00](#)

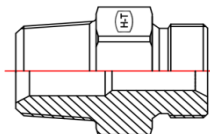

**MP-MBSPP Straight**

[HT7032-00-00](#)

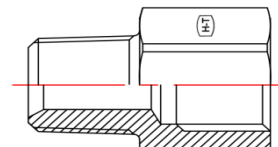

**MP-FBSPP Straight**

[HT7033-00-00](#)

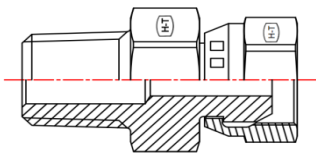

**MP-FBSPPS Straight**

[HT7034-00-00](#)

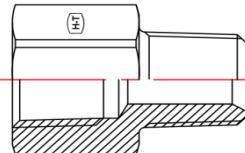

**FP-MBSPT Straight**

[HT7040-00-00](#)

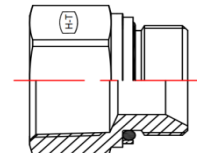

**FP-MBSPP Straight**

[HT7042-00-00](#)

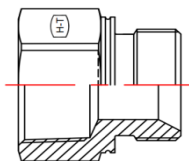

**FP-MM Straight**

[HT7045-00-00](#)

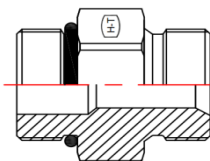

**MORB-MBSPP Straight**

[HT7062-00-00](#)

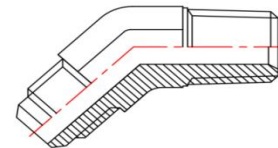

**MJ-MBSPP 45° Elbow**

[HT7100-00-00](#)

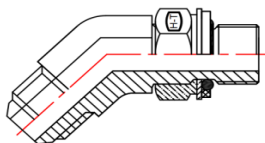

**MJ-MBSPP ADJ. 45° Elbow**

[HT7102-00-00-NWO](#)

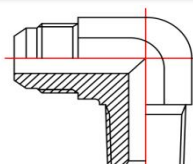

**MJ-MBSPP 90° Elbow**

[HT7200-00-00](#)

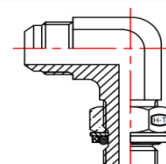

**MJ-MBSPP ADJ. 90° Elbow**

[HT7202-00-00-NWO](#)



[www.HYTECHGROUP.com](http://www.HYTECHGROUP.com)

World class

Hydraulic Fittings, Cylinders, Hoses & Precision Components

ISO 9001-2008 Company



## CONVERSION FITTINGS

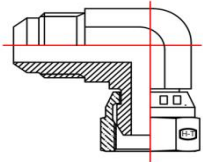

**MJ-FBSPPS 90° Elbow**

[HT7204-00-00](#)

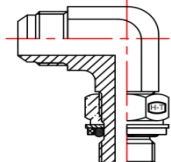

**MJ-MM ADJ. 90° Elbow**

[HT7205-00-00-NWO](#)

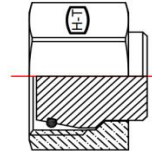

**METRIC LIGHT SERIES TUBE CAP**

[HTD8003-L-00](#)

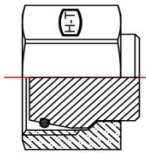

**METRIC HEAVY SERIES TUBE CAP**

[HTD8003-S-00](#)

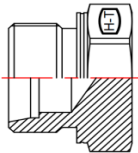

**MM LIGHT SERIES  
TUBE PLUG (DIN2353 S)**

[HTD8004-L-00](#)

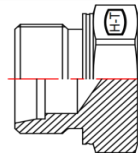

**MM HEAVY SERIES  
TUBE PLUG (DIN2353 S)**

[HT8004-S00](#)

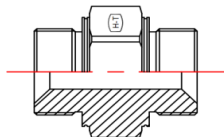

**MM-MM (Metric Nipple)**

[HT8055-00-00](#)

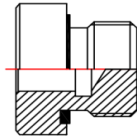

**MM Hollow Hex Plug**

[HT8555-H00-O](#)

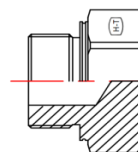

**Metric Hex Plug (ISO6149)**

[HT8055-P-00](#)



**Self Centering Bonded Seal Metric**

[HT8800-00](#)

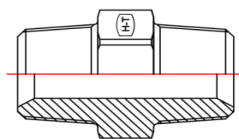

**MBSPT-MBSPT Straight**

[HT9000-00-00](#)

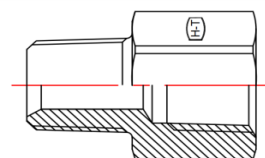

**MBSPT-FMSPT Straight**

[HT9001-00-00](#)



[www.HYTECHGROUP.com](http://www.HYTECHGROUP.com)

World class

Hydraulic Fittings, Cylinders, Hoses & Precision Components

ISO 9001-2008 Company



## CONVERSION FITTINGS

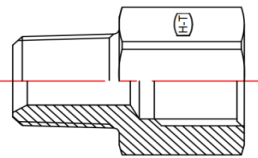

**MBSPT-FMSPP Straight**

[HT9003-00-00](#)

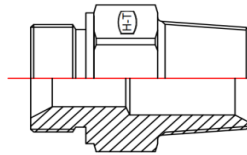

**MBSP-MSPT Straight**

[HT9020-00-00](#)

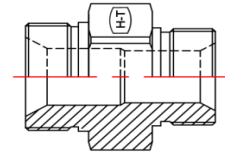

**MBSP-MSPP Straight**

[HT9022-00-00](#)

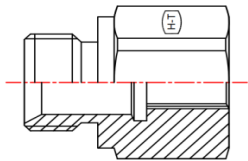

**MBSP-FBSPP Straight**

[HT9023-00-00](#)

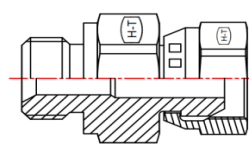

**MBSP-FBSPPS Straight**

[HT9024-00-00](#)

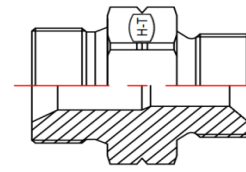

**MBSP-MM Straight**

[HT9025-00-00](#)

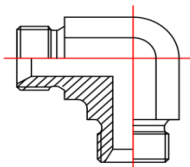

**MBSP-MSPP 90° Elbow**

[HT9222-00-00](#)

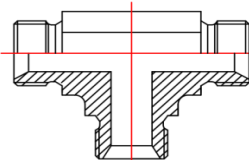

**MBSP TEE**

[HT9322-00-00-00](#)

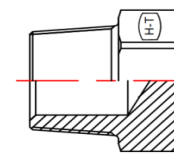

**MBSPT PLUG**

[HT9500-P-00](#)

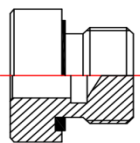

**MBSP-Hollow Hex Plug**

[HT9522-H-00-0](#)

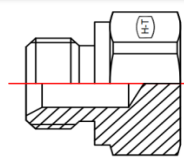

**MBSP-Hex Plug**

[HT9522-P-00](#)

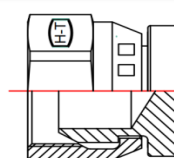

**FBSPP-CAP**

[HT9466-C-00](#)



[www.HYTECHGROUP.com](http://www.HYTECHGROUP.com)

World class

Hydraulic Fittings, Cylinders, Hoses & Precision Components

ISO 9001-2008 Company



## CONVERSION FITTINGS

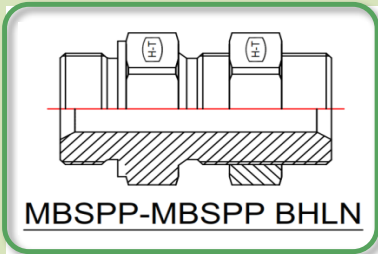

[HT9722-LN-00-00](#)

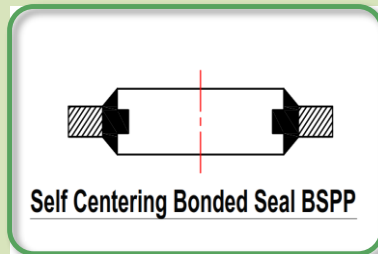

[HT9900-00](#)

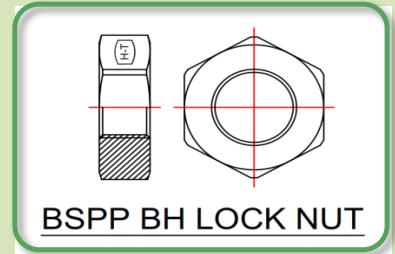

[HT9925-00](#)

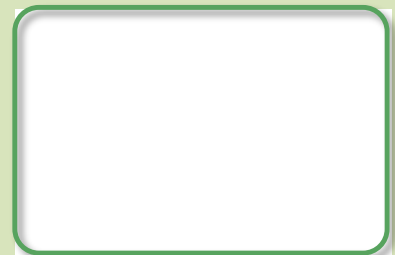
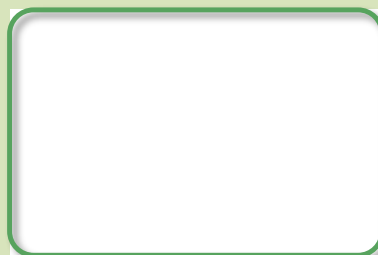
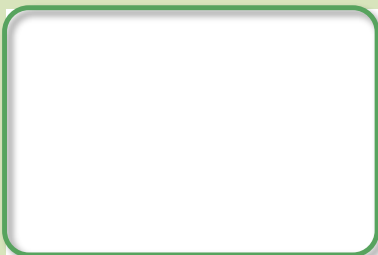
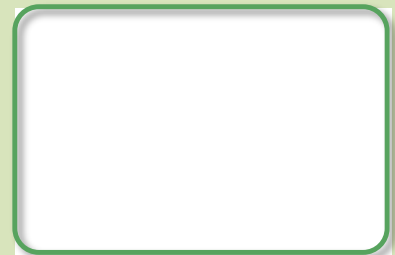
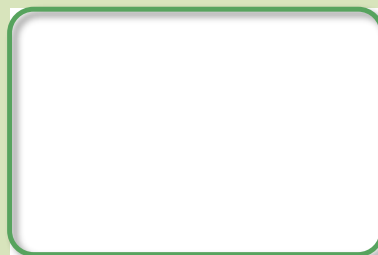
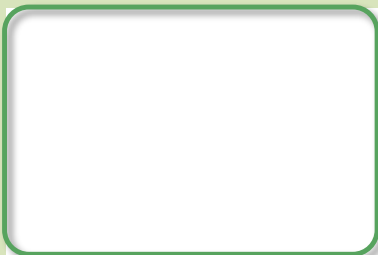
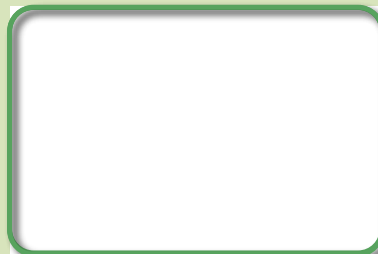
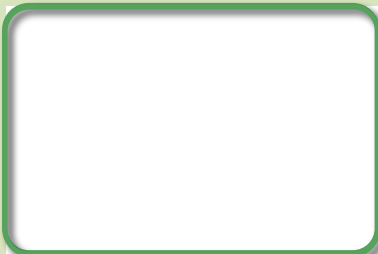



[www.HYTECHGROUP.com](http://www.HYTECHGROUP.com)

World class

Hydraulic Fittings, Cylinders, Hoses & Precision Components

ISO 9001-2008 Company



## CONVERSION FITTINGS - HT7000-00-00

[CONVERSION FITTINGS -](#)

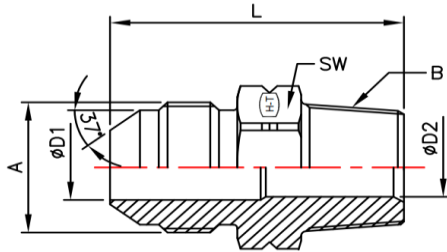

### MJ-MBSPT Straight

SR. NO.	PART NO.	SW	L	A JIC THREAD	ØD1	B BSPT THREAD	ØD2
01	HT7000-04-02	12.0	31.00	7/16"-20UNF	4.40	1/8"-28 BSPT	4.90
02	HT7000-04-04	14.0	35.18	7/16"-20UNF	4.40	1/4"-19BSPT	7.00
03	HT7000-04-06	19.0	35.10	7/16"-20UNF	4.40	3/8"-19BSPT	10.30
04	HT7000-06-04	17.0	36.40	9/16"-18UNF	7.50	1/4"-19BSPT	7.00
05	HT7000-06-06	19.0	36.20	9/16"-18UNF	7.50	3/8"-19BSPT	10.30
06	HT7000-06-08	22.0	41.50	9/16"-18UNF	7.50	1/2"-14BSPT	13.50
07	HT7000-08-04	19.0	39.10	3/4"-16UNF	9.90	1/4"-19BSPT	7.00
08	HT7000-08-06	19.0	38.90	3/4"-16UNF	9.90	3/8"-19BSPT	10.30
09	HT7000-08-08	22.0	44.10	3/4"-16UNF	9.90	1/2"-14BSPT	13.50
10	HT7000-08-12	27.0	45.90	3/4"-16UNF	9.90	3/4"-14BSPT	18.00
11	HT7000-08-16	36.0	53.60	3/4"-16UNF	9.90	1"-11BSPT	23.80
12	HT7000-10-06	24.0	43.20	7/8"-14UNF	12.30	3/8"-19BSPT	10.30
13	HT7000-10-08	24.0	48.00	7/8"-14UNF	12.30	1/2"-14BSPT	13.50
14	HT7000-10-12	27.0	48.50	7/8"-14UNF	12.30	3/4"-14BSPT	18.00
15	HT7000-12-08	27.0	52.30	1-1/16"-12UN	15.50	1/2"-14BSPT	13.50
16	HT7000-12-12	27.0	52.50	1-1/16"-12UN	15.50	3/4"-14BSPT	18.00
17	HT7000-12-16	36.0	56.00	1-1/16"-12UN	15.50	1"-11BSPT	23.80
18	HT7000-14-12	32.0	52.30	1-3/16"-12UN	18.00	3/4"-14BSPT	18.00
19	HT7000-16-12	36.0	53.60	1-5/16"-12UN	21.50	3/4"-14BSPT	18.00
20	HT7000-16-16	36.0	58.50	1-5/16"-12UN	21.50	1"-11BSPT	23.80

ALL REQUIREMENT AS PER SAE J514 & DIN 3900

ALL DIMENSIONS ARE IN MM



[www.HYTECHGROUP.com](http://www.HYTECHGROUP.com)

World class

Hydraulic Fittings, Cylinders, Hoses & Precision Components  
ISO 9001-2008 Company



## CONVERSION FITTINGS - HT7001-00-00

[CONVERSION FITTINGS -](#)

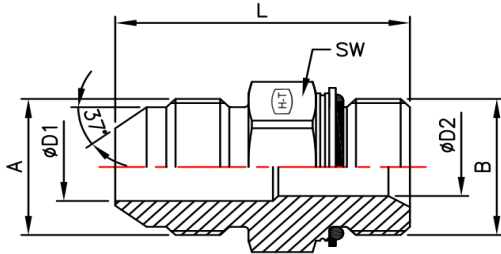

### MJ-MM Straight

SR. NO.	PART NO.	SW	L	A JIC THREAD	ØD1	B METRIC THREAD	ØD2
01	HT7001-04-10	14.0	30.00	7/16"-20UNF	4.40	M10X1.0 6g	4.40
02	HT7001-04-12	17.0	33.00	7/16"-20UNF	4.40	M12X1.5 6g	6.00
03	HT7001-04-14	19.0	34.00	7/16"-20UNF	4.40	M14X1.5 6g	7.50
04	HT7001-06-12	19.0	33.10	9/16"-18UNF	7.50	M12X1.5 6g	6.00
05	HT7001-06-14	19.0	34.00	9/16"-18UNF	7.50	M14X1.5 6g	7.50
06	HT7001-06-16	22.0	36.00	9/16"-18UNF	7.50	M16X1.5 6g	9.00
07	HT7001-06-18	24.0	37.00	9/16"-18UNF	7.50	M18X1.5 6g	11.00
08	HT7001-08-14	22.0	37.00	3/4"-16UNF	9.90	M14X1.5 6g	7.50
09	HT7001-08-16	22.0	38.00	3/4"-16UNF	9.90	M16X1.5 6g	9.00
10	HT7001-08-18	24.0	39.00	3/4"-16UNF	9.90	M18X1.5 6g	11.00
11	HT7001-08-22	27.0	42.00	3/4"-16UNF	9.90	M22X1.5 6g	14.00
12	HT7001-10-18	24.0	43.00	7/8"-14UNF	12.30	M18X1.5 6g	11.00
13	HT7001-10-20	27.0	44.00	7/8"-14UNF	12.30	M20X1.5 6g	12.50
14	HT7001-10-22	27.0	44.00	7/8"-14UNF	12.30	M22X1.5 6g	14.00
15	HT7001-12-22	27.0	48.00	1-1/16"-12UN	15.50	M22X1.5 6g	14.00
16	HT7001-12-26	32.0	51.00	1-1/16"-12UN	15.50	M26X1.5 6g	16.00
17	HT7001-12-27	32.0	51.00	1-1/16"-12UN	15.50	M27X2.0 6g	18.00
18	HT7001-16-27	41.0	51.00	1-5/16"-12UN	21.50	M27X2.0 6g	18.00
19	HT7001-16-33	41.0	53.00	1-5/16"-12UN	21.50	M33X2.0 6g	23.00

ALL REQUIREMENT AS PER SAE J514 & ISO 6149-3

ALL DIMENSIONS ARE IN MM



[www.HYTECHGROUP.com](http://www.HYTECHGROUP.com)

World class

Hydraulic Fittings, Cylinders, Hoses & Precision Components

ISO 9001-2008 Company



## CONVERSION FITTINGS - HT7002-00-00-ORR

[CONVERSION FITTINGS -](#)

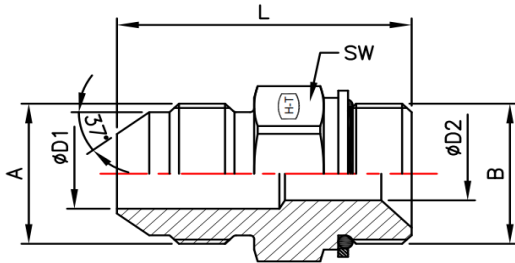

### MJ-MBSPP Straight

SR. NO.	PART NO.	SW	L	A JIC THREAD	ØD1	B BSPP THREAD	ØD2
01	HT7002-04-04-ORR	19.0	32.0	7/16"-20UNF	4.40	1/4"-19BSPP	4.70
02	HT7002-04-06-ORR	22.0	34.0	7/16"-20UNF	4.40	3/8"-19BSPP	7.90
03	HT7002-06-04-ORR	19.0	33.0	9/16"-18UNF	7.50	1/4"-19BSPP	4.70
04	HT7002-06-06-ORR	22.0	34.1	9/16"-18UNF	7.50	3/8"-19BSPP	7.90
05	HT7002-06-08-ORR	27.0	38.0	9/16"-18UNF	7.50	1/2"-14BSPP	12.70
06	HT7002-08-06-ORR	22.0	37.5	3/4"-16UNF	9.90	3/8"-19BSPP	9.50
07	HT7002-08-08-ORR	27.0	41.0	3/4"-16UNF	9.90	1/2"-14BSPP	11.10
08	HT7002-08-12-ORR	32.0	44.7	3/4"-16UNF	9.90	3/4"-14BSPP	16.70
09	HT7002-10-08-ORR	27.0	45.0	7/8"-14UNF	12.30	1/2"-14BSPP	12.70
10	HT7002-10-12-ORR	32.0	49.0	7/8"-14UNF	12.30	3/4"-14BSPP	18.20
11	HT7002-12-08-ORR	27.0	47.0	1-1/16"-12UN	15.50	1/2"-14BSPP	11.10
12	HT7002-12-12-ORR	32.0	52.0	1-1/16"-12UN	15.50	3/4"-14BSPP	18.20
13	HT7002-12-16-ORR	41.0	53.0	1-1/16"-12UN	15.50	1"-11BSPP	22.20
14	HT7002-16-12-ORR	36.0	50.1	1-5/16"-12UN	21.50	3/4"-14BSPP	16.70
15	HT7002-16-16-ORR	41.0	57.1	1-5/16"-12UN	21.50	1"-11BSPP	22.20
16	HT7002-16-24-ORR	55.0	59.0	1-5/16"-12UN	21.50	1-1/2"-11BSPP	33.30

ALL REQUIREMENT AS PER SAE J514 & ISO 6149-3

ALL DIMENSIONS ARE IN MM





[www.HYTECHGROUP.com](http://www.HYTECHGROUP.com)

World class

Hydraulic Fittings, Cylinders, Hoses & Precision Components  
ISO 9001-2008 Company



## CONVERSION FITTINGS - HT7003-00-00

CONVERSION FITTINGS -

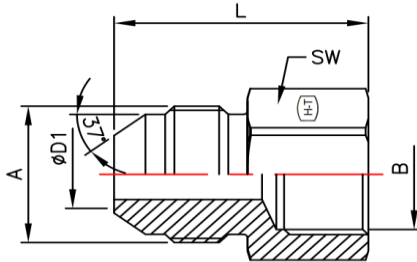

### MJ-FBSPP Straight

SR. NO.	PART NO.	SW	L	A JIC THREAD	ØD1	B BSPP THREAD (INT)
01	HT7003-04-04	19.0	33.00	7/16"-20UNF	4.40	1/4"-19BSPP
02	HT7003-06-04	19.0	33.10	9/16"-18UNF	7.50	1/4"-19BSPP
03	HT7003-06-06	22.0	35.10	9/16"-18UNF	7.50	3/8"-19BSPP
04	HT7003-08-06	22.0	37.70	3/4"-16UNF	9.90	3/8"-19BSPP
05	HT7003-08-08	27.0	39.70	3/4"-16UNF	9.90	1/2"-14BSPP
06	HT7003-12-12	32.0	49.90	1-1/16"-12UN	15.50	3/4"-14BSPP
07	HT7003-16-16	41.0	54.10	1-5/16"-12UN	21.50	1"11BSPP

ALL REQUIREMENT AS PER SAE J514 & BS:5200

ALL DIMENSIONS ARE IN MM



[www.HYTECHGROUP.com](http://www.HYTECHGROUP.com)

World class

Hydraulic Fittings, Cylinders, Hoses & Precision Components  
ISO 9001-2008 Company



## CONVERSION FITTINGS - HT7004-00-00

CONVERSION FITTINGS -

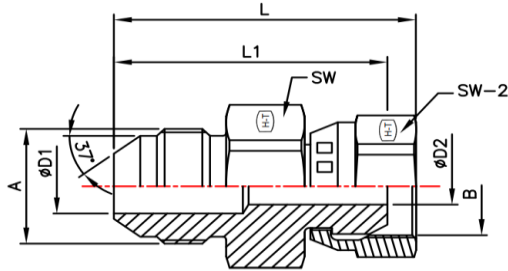

**MJ-FBSPS Straight**

SR. NO.	PART NO.	SW	L	L1	A JIC THREAD	ØD1	B BSPP THREAD (INT)	ØD2	SW-2
01	HT7004-04-02	14.00	36.00	31.70	7/16"-20UNF	4.40	1/8"-28BSPP	3.50	14.00
02	HT7004-04-04	19.00	36.58	31.40	7/16"-20UNF	4.40	1/4"-19BSPP	4.70	19.00
03	HT7004-04-06	22.00	43.50	37.50	7/16"-20UNF	4.40	3/8"-19BSPP	7.90	22.00
04	HT7004-06-04	19.00	36.50	31.30	9/16"-18UNF	7.50	1/4"-19BSPP	4.50	19.00
05	HT7004-06-06	19.00	40.64	34.70	9/16"-18UNF	7.50	3/8"-19BSPP	7.90	22.00
06	HT7004-06-08	27.00	46.50	40.00	9/16"-18UNF	7.50	1/2"-14BSPP	11.10	27.00
07	HT7004-08-06	22.00	42.30	36.50	3/4"-16UNF	9.90	3/8"-19BSPP	7.10	22.00
08	HT7004-08-08	27.00	49.02	42.50	3/4"-16UNF	9.90	1/2"-14BSPP	11.10	27.00
09	HT7004-08-10	27.00	53.70	44.00	3/4"-16UNF	9.90	5/8"-14BSPP	14.30	30.00
10	HT7004-08-12	27.00	53.70	45.00	3/4"-16UNF	9.90	3/4"-14BSPP	16.70	32.00
11	HT7004-10-08	24.00	50.50	44.00	7/8"-14UNF	12.30	1/2"-14BSPP	9.70	27.00
12	HT7004-10-10	27.00	52.50	42.80	7/8"-14UNF	12.30	5/8"-14BSPP	14.30	30.00
13	HT7004-10-12	27.00	56.30	47.60	7/8"-14UNF	12.30	3/4"-14BSPP	16.70	32.00
14	HT7004-12-12	27.00	58.00	49.30	1-1/16"-12UN	15.50	3/4"-14BSPP	16.70	32.00
15	HT7004-12-16	36.00	68.90	58.40	1-1/16"-12UN	15.50	1"-11BSPP	22.20	41.00
16	HT7004-16-12	36.00	59.10	50.40	1-5/16"-12UN	21.50	3/4"-14BSPP	15.50	32.00
17	HT7004-16-16	41.00	60.00	49.50	1-5/16"-12UN	21.50	1"-11BSPP	22.20	41.00

ALL REQUIREMENT AS PER SAE J514 ,ISO8434 & BS:5200

ALL DIMENSIONS ARE IN MM



[www.HYTECHGROUP.com](http://www.HYTECHGROUP.com)

World class

Hydraulic Fittings, Cylinders, Hoses & Precision Components  
ISO 9001-2008 Company



## CONVERSION FITTINGS - HT7005-00-L00-00

[CONVERSION FITTINGS -](#)

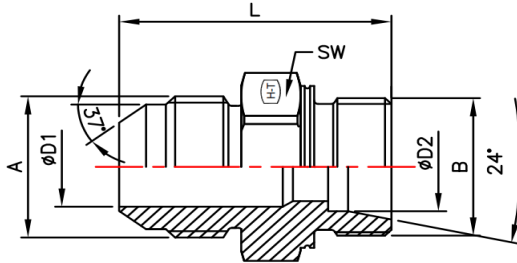

### MJ-MM DUAL PURPOSE (L)

S.R. NO.	PART NO.	SW	L	A JIC THREAD	ØD1	B MM THREAD	ØD2
01	HT7005-04-L06-12	17.00	32.50	7/16"-20UNF	4.40	M12X1.5 6g	6.00
02	HT7005-04-L08-14	19.00	33.50	7/16"-20UNF	4.40	M14X1.5 6g	8.00
03	HT7005-04-L10-16	22.00	35.50	7/16"-20UNF	4.40	M16X1.5 6g	10.00
04	HT7005-06-L08-12	17.00	32.60	9/16"-18UNF	7.50	M12X1.5 6g	6.00
05	HT7005-06-L08-14	19.00	33.60	9/16"-18UNF	7.50	M14X1.5 6g	8.00
06	HT7005-06-L10-16	22.00	35.60	9/16"-18UNF	7.50	M16X1.5 6g	10.00
07	HT7005-06-L12-18	24.00	37.60	9/16"-18UNF	7.50	M18X1.5 6g	12.00
08	HT7005-06-L15-22	27.00	38.60	9/16"-18UNF	7.50	M22X1.5 6g	15.00
09	HT7005-08-L10-16	22.00	38.20	3/4"-16UNF	9.90	M16X1.5 6g	10.00
10	HT7005-08-L12-18	24.00	40.20	3/4"-16UNF	9.90	M18X1.5 6g	12.00
11	HT7005-08-L15-22	27.00	41.20	3/4"-16UNF	9.90	M22X1.5 6g	15.00
12	HT7005-10-L12-18	24.00	42.80	7/8"-14UNF	12.30	M18X1.5 6g	12.00
13	HT7005-10-L15-22	27.00	43.80	7/8"-14UNF	12.30	M22X1.5 6g	15.00
14	HT7005-10-L18-26	32.00	47.80	7/8"-14UNF	12.30	M26X1.5 6g	18.00
15	HT7005-12-L15-22	27.00	46.40	1-1/16"-12UN	15.50	M22X1.5 6g	15.00
16	HT7005-12-L18-24	27.00	46.40	1-1/16"-12UN	15.50	M24X1.5 6g	16.00
17	HT7005-12-L18-26	32.00	50.40	1-1/16"-12UN	15.50	M26X1.5 6g	18.00
18	HT7005-12-L22-30	36.00	52.90	1-1/16"-12UN	15.50	M30X2.0 6g	22.00
19	HT7005-16-L22-30	36.00	54.10	1-5/16"-12UN	21.40	M30X2.0 6g	22.00
20	HT7005-16-L28-36	41.00	55.10	1-5/16"-12UN	21.40	M36X2.0 6g	28.00
21	HT7005-20-L35-45	46.00	58.30	1-5/8"-12UN	27.40	M45X2.0 6g	35.30
22	HT7005-24-L42-52	55.00	61.50	1-7/8"-12UN	33.30	M52X2.0 6g	42.30

ALL REQUIREMENT AS PER SAE J514 ,ISO 8434 & ISO 6149

ALL DIMENSIONS ARE IN MM



[www.HYTECHGROUP.com](http://www.HYTECHGROUP.com)

World class

Hydraulic Fittings, Cylinders, Hoses & Precision Components  
ISO 9001-2008 Company



## CONVERSION FITTINGS - HT7005-00-S00-00

[CONVERSION FITTINGS -](#)

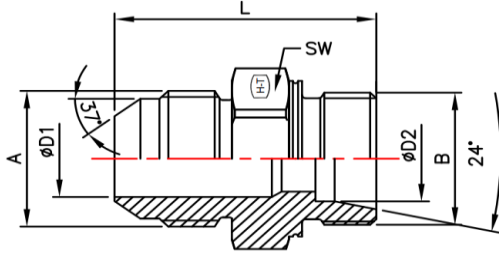

### MJ-MM DUAL PURPOSE (S)

SR. NO.	PART NO.	SW	L	A JIC THREAD	ØD1	B MM THREAD	ØD2
01	HT7005-04-S06-14	19.00	33.50	7/16"-20UNF	4.40	M14X1.5 6g	6.00
02	HT7005-04-S08-16	22.00	36.50	7/16"-20UNF	4.40	M16X1.5 6g	8.00
03	HT7005-06-S08-16	22.00	36.60	9/16"-18UNF	7.50	M16X1.5 6g	8.00
04	HT7005-06-S10-18	24.00	39.10	9/16"-18UNF	7.50	M18X1.5 6g	10.00
05	HT7005-06-S12-20	24.00	39.10	9/16"-18UNF	7.50	M20X1.5 6g	12.00
06	HT7005-08-S08-16	22.00	39.20	3/4"-16UNF	9.90	M16X1.5 6g	8.00
07	HT7005-08-S10-18	24.00	41.70	3/4"-16UNF	9.90	M18X1.5 6g	10.00
08	HT7005-08-S12-20	24.00	41.70	3/4"-16UNF	9.90	M20X1.5 6g	12.00
09	HT7005-08-S14-22	27.00	43.20	3/4"-16UNF	9.90	M22X1.5 6g	14.00
10	HT7005-08-S16-24	27.00	43.20	3/4"-16UNF	9.90	M24X1.5 6g	16.00
11	HT7005-10-S12-20	24.00	44.30	7/8"-14UNF	12.30	M20X1.5 6g	12.00
12	HT7005-10-S16-24	27.00	45.80	7/8"-14UNF	12.30	M24X1.5 6g	16.00
13	HT7005-12-S16-24	27.00	48.40	1-1/16"-12UN	15.50	M24X1.5 6g	16.00
14	HT7005-12-S20-30	36.00	55.40	1-1/16"-12UN	15.50	M30X2.0 6g	20.00
15	HT7005-12-S25-36	41.00	56.90	1-1/16"-12UN	15.50	M36X2.0 6g	25.00
16	HT7005-16-S30-42	50.00	61.10	1-5/16"-12UN	21.40	M42X2.0 6g	30.00
17	HT7005-20-S38-52	55.00	64.30	1-5/8"-12UN	27.40	M52X2.0 6g	38.00
18	HT7005-24-S38-52	55.00	67.50	1-7/8"-12UN	33.30	M32X2.0 6g	38.30

ALL REQUIREMENT AS PER SAE J514 ,ISO 8434 & ISO 6149

ALL DIMENSIONS ARE IN MM



[www.HYTECHGROUP.com](http://www.HYTECHGROUP.com)

World class

Hydraulic Fittings, Cylinders, Hoses & Precision Components  
ISO 9001-2008 Company



## CONVERSION FITTINGS - HT7022-00-00

### CONVERSION FITTINGS -

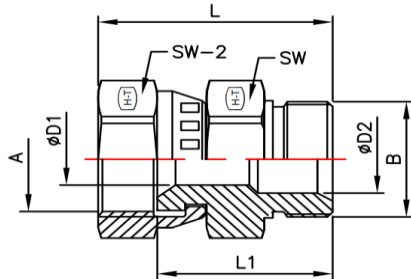

### FJS-MBSPP STRAIGHT

SR. NO.	PART NO.	SW	L	L1	A		B		ØD2	SW-2
					UNF THREAD (INT)	ØD1	BSPP THREAD	ØD2		
01	HT7022-04-02	14.00	30.00	26.00	7/16"-20UNF	4.40	1/8"-28BSPP	3.50	14.00	
02	HT7022-04-04	19.00	36.70	30.00	7/16"-20UNF	4.40	1/4"-19BSPP	4.70	14.00	
03	HT7022-04-06	22.00	40.00	32.50	7/16"-20UNF	4.40	3/8"-19BSPP	7.90	14.00	
04	HT7022-06-04	19.00	40.00	32.50	9/16"-18UNF	7.50	1/4"-19BSPP	4.70	19.00	
05	HT7022-06-06	22.00	42.00	35.00	9/16"-18UNF	7.50	3/8"-19BSPP	7.90	19.00	
06	HT7022-06-08	27.00	46.00	39.50	9/16"-18UNF	7.50	1/2"-14BSPP	11.10	19.00	
07	HT7022-08-06	22.00	43.40	35.20	3/4"-16UNF	9.90	3/8"-19BSPP	7.90	22.00	
08	HT7022-08-08	27.00	47.40	39.70	3/4"-16UNF	9.90	1/2"-14BSPP	11.10	22.00	
09	HT7022-08-10	30.00	51.40	43.70	3/4"-16UNF	9.90	5/8"-14BSPP	14.30	22.00	
10	HT7022-08-12	32.00	54.40	43.70	3/4"-16UNF	9.90	3/4"-14BSPP	16.70	22.00	
11	HT7022-10-06	22.00	45.70	35.50	7/8"-14UNF	12.30	3/8"-19BSPP	7.90	27.00	
12	HT7022-10-08	27.00	49.70	40.00	7/8"-14UNF	12.30	1/2"-14BSPP	11.10	27.00	
13	HT7022-10-10	30.00	53.70	44.00	7/8"-14UNF	12.30	5/8"-14BSPP	14.30	27.00	
14	HT7022-12-08	27.00	51.50	40.00	1-1/16"-12UN	15.50	1/2"-14BSPP	11.10	32.00	
15	HT7022-12-10	30.00	55.50	41.20	1-1/16"-12UN	15.50	5/8"-14BSPP	14.30	32.00	
16	HT7022-12-12	32.00	58.50	44.20	1-1/16"-12UN	15.50	3/4"-14BSPP	16.70	32.00	
17	HT7022-12-16	41.00	67.50	53.20	1-1/16"-12UN	15.50	1"-11BSPP	22.20	32.00	
18	HT7022-16-12	36.00	61.20	46.10	1-5/16"-12UN	21.40	3/4"-14BSPP	16.70	41.00	
19	HT7022-16-16	41.00	70.20	55.10	1-5/16"-12UN	21.40	1"-11BSPP	22.20	41.00	

ALL REQUIREMENT AS PER SAE J514 & BS:5200

ALL DIMENSIONS ARE IN MM



[www.HYTECHGROUP.com](http://www.HYTECHGROUP.com)

World class

Hydraulic Fittings, Cylinders, Hoses & Precision Components

ISO 9001-2008 Company



## CONVERSION FITTINGS - HT7023-00-00

CONVERSION FITTINGS -

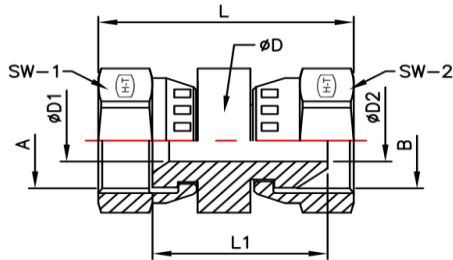

### FJS-FBSPPS Straight

SR. NO.	PART NO.	L	ØD	L1	SW-1	A		B		
						UNF THREAD (INT)	ØD1	SW-2	BSPS THREAD (INT)	ØD2
01	HT7023-04-04	41.80	17.00	27.90	14.00	7/16"-20UNF-2B	4.40	19.00	1/4"-14BSPP	4.50
02	HT7023-04-06	42.90	20.00	28.20	14.00	7/16"-20UNF-2B	4.40	22.00	3/8"-19BSPP	7.10
03	HT7023-06-04	44.30	17.00	29.60	19.00	9/16"-18UNF-2B	7.50	19.00	1/4"-14BSPP	4.50
04	HT7023-06-06	45.40	20.00	29.90	19.00	9/16"-18UNF-2B	7.50	22.00	3/8"-19BSPP	7.10
05	HT7023-06-08	48.40	25.00	32.40	19.00	9/16"-18UNF-2B	7.50	27.00	1/2"-14BSPP	9.70
06	HT7023-08-06	47.80	20.00	31.10	22.00	3/4"-16UNF-2B	9.90	22.00	3/8"-19BSPP	7.10
07	HT7023-08-08	49.80	25.00	32.60	22.00	3/4"-16UNF-2B	9.90	27.00	1/2"-14BSPP	9.70
08	HT7023-08-12	56.30	30.00	36.90	22.00	3/4"-16UNF-2B	9.90	32.00	3/4"-14BSPP	15.50
09	HT7023-10-10	56.10	28.00	33.70	27.00	7/8"-14UNF-2B	12.30	30.00	5/8"-14BSPP	12.00
10	HT7023-12-12	60.40	30.00	37.40	32.00	1-1/16"-12UN-2B	15.50	32.00	3/4"-14BSPP	15.50
11	HT7023-12-16	64.20	39.00	39.40	32.00	1-1/16"-12UN-2B	15.50	41.00	1"-11BSPP	20.40
12	HT7023-16-12	63.10	39.00	39.30	41.00	1-5/16"-12UN-2B	21.40	32.00	3/4"-14BSPP	15.50
13	HT7023-16-16	68.90	39.00	43.30	41.00	1-5/16"-12UN-2B	21.40	41.00	1"-11BSPP	20.40

ALL REQUIREMENT AS PER SAE J514, ISO:8434 & BS:5200

ALL DIMENSIONS ARE IN MM



[www.HYTECHGROUP.com](http://www.HYTECHGROUP.com)

World class

Hydraulic Fittings, Cylinders, Hoses & Precision Components  
ISO 9001-2008 Company



## CONVERSION FITTINGS - HT7025-00-00

[CONVERSION FITTINGS -](#)

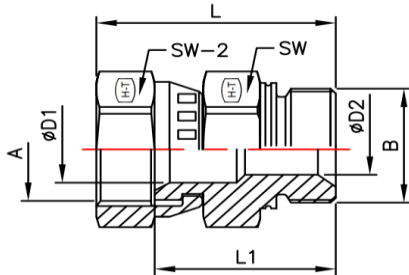

**FJS-MM Straight**

Sr. NO.	PART NO.	SW	L	L1	SW-2	A UNF THREAD (INT)	ØD1	B BSPP THREAD	ØD2
01	HT7025-06-14	19.00	40.00	30.50	19.00	9/16"-18UNF	7.50	M14X1.5 6g	7.50
02	HT7025-06-16	22.00	40.50	31.00	19.00	9/16"-18UNF	7.50	M16X1.5 6g	9.00
03	HT7025-06-18	24.00	40.50	33.50	19.00	9/16"-18UNF	7.50	M18X1.5 6g	11.00
04	HT7025-06-20	27.00	43.70	34.20	19.00	9/16"-18UNF	7.50	M20X1.5 6g	12.50
05	HT7025-06-22	27.00	43.70	36.00	19.00	9/16"-18UNF	7.50	M22X1.5 6g	14.00
06	HT7025-08-16	22.00	42.60	33.00	22.00	3/4"-16UNF	9.90	M16X1.5 6g	9.00
07	HT7025-08-18	24.00	42.60	34.00	22.00	3/4"-16UNF	9.90	M18X1.5 6g	11.00
08	HT7025-08-20	27.00	46.10	35.40	22.00	3/4"-16UNF	9.90	M20X1.5 6g	12.50
09	HT7025-08-22	27.00	46.10	35.40	22.00	3/4"-16UNF	9.90	M22X1.5 6g	14.00
10	HT7025-10-16	24.00	45.90	36.00	27.00	7/8"-14UNF	12.30	M16X1.5 6g	9.00
11	HT7025-10-18	24.00	45.90	36.00	27.00	7/8"-14UNF	12.30	M18X1.5 6g	11.00
12	HT7025-10-20	27.00	49.40	36.70	27.00	7/8"-14UNF	12.30	M20X1.5 6g	12.50
13	HT7025-10-22	27.00	49.40	36.70	27.00	7/8"-14UNF	12.30	M22X1.5 6g	14.00

ALL REQUIREMENT AS PER DIN 7631, ISO 8434, ISO 6149 & SAE J514

ALL DIMENSIONS ARE IN MM



[www.HYTECHGROUP.com](http://www.HYTECHGROUP.com)

World class

Hydraulic Fittings, Cylinders, Hoses & Precision Components  
ISO 9001-2008 Company



## CONVERSION FITTINGS - HT7030-00-00

[CONVERSION FITTINGS -](#)

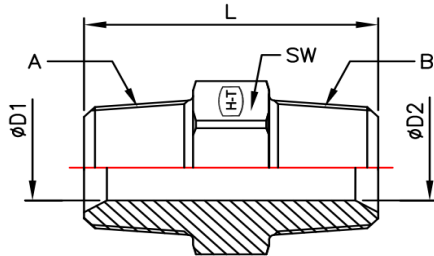

### MP-MBSPT Straight

SR. NO.	PART NO.	SW	L	A NPTF THREAD	ØD1	B BSPT THREAD	ØD2
01	HT7030-04-04	14.0	35.80	1/4"-18NPTF	7.00	1/4"-19BSPT	7.00
02	HT7030-04-06	19.0	35.80	1/4"-18NPTF	7.00	3/8"-19BSPT	10.30
03	HT7030-06-04	19.0	37.00	3/8"-18NPTF	10.30	1/4"-19BSPT	7.00
04	HT7030-06-06	19.0	40.00	3/8"-18NPTF	10.30	3/8"-19BSPT	10.30
05	HT7030-08-08	22.0	49.80	1/2"-14NPTF	12.70	1/2"-14BSPT	12.70
06	HT7030-12-12	27.0	48.70	3/4"-14NPTF	18.00	3/4"-14BSPT	18.00
07	HT7030-16-16	36.0	58.50	1"-11-1/2NPTF	23.80	1"-11BSPT	23.80

ALL REQUIREMENT AS PER SAE J514 & DIN 3900

ALL DIMENSIONS ARE IN MM





[www.HYTECHGROUP.com](http://www.HYTECHGROUP.com)

World class

Hydraulic Fittings, Cylinders, Hoses & Precision Components

ISO 9001-2008 Company



## CONVERSION FITTINGS - HT7032-00-00

### CONVERSION FITTINGS -

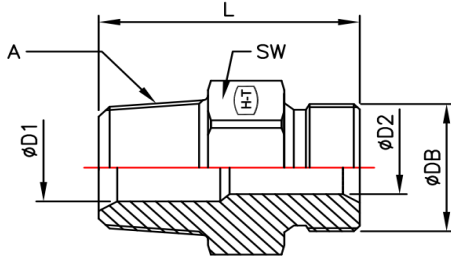

### MP-MBSPP Straight

SR. NO.	PART NO.	SW	L	A NPTF THREAD	ØD1	B BSPP THREAD	ØD2
01	HT7032-04-04	19.0	33.00	1/4"-18NPTF	7.00	1/4"-19BSPP	4.70
02	HT7032-04-06	22.0	34.70	1/4"-18NPTF	7.00	3/8"-19BSPP	7.90
03	HT7032-04-08	27.0	38.70	1/4"-18NPTF	7.00	1/2"-14BSPP	12.70
04	HT7032-04-12	32.0	42.70	1/4"-18NPTF	7.00	3/4"-14BSPP	16.70
05	HT7032-06-04	22.0	35.10	3/8"-18NPTF	10.30	1/4"-19BSPP	4.70
06	HT7032-06-06	22.0	35.10	3/8"-18NPTF	10.30	3/8"-19BSPP	7.90
07	HT7032-06-08	27.0	38.70	3/8"-18NPTF	10.30	1/2"-14BSPP	12.70
08	HT7032-06-12	32.0	42.70	3/8"-18NPTF	10.30	3/4"-14BSPP	16.70
09	HT7032-08-04	22.0	38.40	1/2"-14NPTF	13.50	1/4"-19BSPP	4.70
10	HT7032-08-06	22.0	39.90	1/2"-14NPTF	13.50	3/8"-19BSPP	7.90
11	HT7032-08-08	27.0	43.50	1/2"-14NPTF	13.50	1/2"-14BSPP	12.70
12	HT7032-08-10	30.0	47.50	1/2"-14NPTF	13.50	5/8"-14BSPP	14.30
13	HT7032-08-12	32.0	47.50	1/2"-14NPTF	13.50	3/4"-14BSPP	16.70
14	HT7032-08-16	41.0	53.50	1/2"-14NPTF	13.50	1"-11BSPP	22.20
15	HT7032-12-06	27.0	41.20	3/4"-14NPTF	18.00	3/8"-19BSPP	7.90
16	HT7032-12-08	27.0	43.20	3/4"-14NPTF	18.00	1/2"-14BSPP	12.70
17	HT7032-12-10	30.0	47.50	3/4"-14NPTF	18.00	5/8"-14BSPP	14.30
18	HT7032-12-12	32.0	47.50	3/4"-14NPTF	18.00	3/4"-14BSPP	16.70
19	HT7032-12-16	41.0	53.50	3/4"-14NPTF	18.00	1"-11BSPP	22.20
20	HT7032-16-06	36.0	48.10	1"-11-1/2NPTF	23.80	3/8"-19BSPP	7.90
21	HT7032-16-08	36.0	48.10	1"-11-1/2NPTF	23.80	1/2"-14BSPP	12.70
22	HT7032-16-12	36.0	50.10	1"-11-1/2NPTF	23.80	3/4"-14BSPP	16.70
23	HT7032-16-16	41.0	58.40	1"-11-1/2NPTF	23.80	1"-11BSPP	22.20

ALL REQUIREMENT AS PER SAE J514/ BS:5200

ALL DIMENSIONS ARE IN MM



[www.HYTECHGROUP.com](http://www.HYTECHGROUP.com)

World class

Hydraulic Fittings, Cylinders, Hoses & Precision Components  
ISO 9001-2008 Company



## CONVERSION FITTINGS - HT7033-00-00

### CONVERSION FITTINGS -

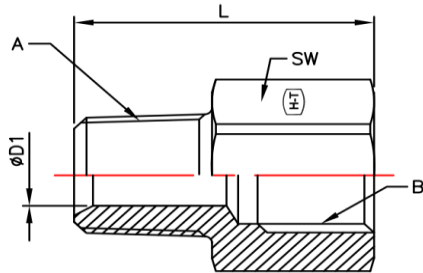

### MP-FBSPP Straight

SR. NO.	PART NO.	SW	L	A NPTF THREAD	ØD1	B BSPP THREAD (INT)
01	HT7033-04-04	19.0	33.78	1/4"-18NPTF	7.00	1/4"-19BSPP
02	HT7033-04-06	22.0	36.50	1/4"-18NPTF	7.00	3/8"-19BSPP
03	HT7033-06-04	19.0	33.27	3/8"-18NPTF	10.30	1/4"-19BSPP
04	HT7033-06-06	22.0	35.70	3/8"-18NPTF	10.30	3/8"-19BSPP
05	HT7033-08-04	22.0	27.40	1/2"-14NPTF	13.50	1/4"-19BSPP
06	HT7033-08-06	22.0	39.88	1/2"-14NPTF	13.50	3/8"-19BSPP
07	HT7033-08-08	30.0	47.00	1/2"-14NPTF	13.50	1/2"-14BSPP
08	HT7033-08-12	36.0	49.00	1/2"-14NPTF	13.50	3/4"-14BSPP
09	HT7033-12-04	30.0	42.00	3/4"-14NPTF	18.00	1/4"-19BSPP
10	HT7033-12-06	30.0	29.00	3/4"-14NPTF	18.00	3/8"-19BSPP
11	HT7033-12-08	30.0	44.00	3/4"-14NPTF	18.00	1/2"-14BSPP
12	HT7033-12-12	36.0	47.00	3/4"-14NPTF	18.00	3/4"-14BSPP
13	HT7033-16-06	36.0	35.00	1"-11-1/2NPTF	23.80	3/8"-19BSPP
14	HT7033-16-08	36.0	35.00	1"-11-1/2NPTF	23.80	1/2"-14BSPP
15	HT7033-16-12	36.0	50.00	1"-11-1/2NPTF	23.80	3/4"-14BSPP
16	HT7033-16-16	41.0	61.50	1"-11-1/2NPTF	23.80	1"11BSPP

ALL REQUIREMENT AS PER SAE J514 & ISO 8434, ISO 1179

ALL DIMENSIONS ARE IN MM



[www.HYTECHGROUP.com](http://www.HYTECHGROUP.com)

World class

Hydraulic Fittings, Cylinders, Hoses & Precision Components  
ISO 9001-2008 Company



## CONVERSION FITTINGS - HT7034-00-00

CONVERSION FITTINGS -

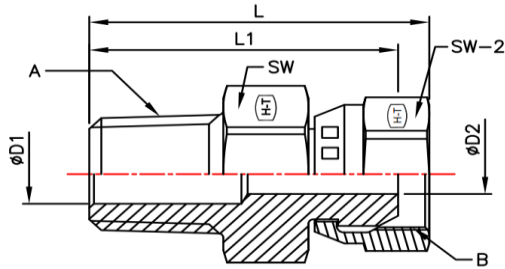

### MP-FBSPPS Straight

SR. NO.	PART NO.	SW	L	L1	A NPTF THREAD	ØD1	B BSPP THREAD (INT)	Ød2	SW-2
01	HT7034-04-04	17.00	38.00	32.90	1/4"-18NPTF	7.00	1/4"-19BSPP	4.70	19.00
02	HT7034-06-04	19.00	38.10	32.90	3/8"-18NPTF	10.30	1/4"-19BSPP	4.70	19.00
03	HT7034-06-06	19.00	40.10	34.10	3/8"-18NPTF	10.30	3/8"-19BSPP	7.90	22.00
04	HT7034-06-08	22.00	46.70	40.20	3/8"-18NPTF	10.30	1/2"-14BSPP	11.10	27.00
05	HT7034-08-06	22.00	46.40	40.40	1/2"-14NPTF	13.50	3/8"-19BSPP	7.90	22.00
06	HT7034-08-08	22.00	51.00	42.90	1/2"-14NPTF	13.50	1/2"-14BSPP	11.10	27.00
07	HT7034-12-08	30.00	51.20	44.70	3/4"-14NPTF	18.30	1/2"-14BSPP	11.10	27.00
08	HT7034-12-12	30.00	55.00	45.50	3/4"-14NPTF	18.30	3/4"-14BSPP	16.70	32.00
09	HT7034-16-12	36.00	59.10	50.40	1"-11-1/2NPTF	23.80	3/4"-14BSPP	16.70	32.00
10	HT7034-16-16	36.00	66.10	55.60	1"-11-1/2NPTF	23.80	1"-11BSPP	22.20	41.00

ALL REQUIREMENT AS PER SAE J514 ,ISO8434 & BS:5200

ALL DIMENSIONS ARE IN MM



[www.HYTECHGROUP.com](http://www.HYTECHGROUP.com)

World class

Hydraulic Fittings, Cylinders, Hoses & Precision Components  
ISO 9001-2008 Company



## CONVERSION FITTINGS - HT7040-00-00

[CONVERSION FITTINGS -](#)

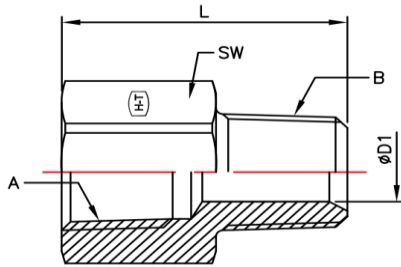

**FP-MBSPT Straight**

SR. NO.	PART NO.	SW	L	A NPTF THREAD (INT)	B BSPT THREAD	$\phi D1$
01	HT7040-02-02	17.0	27.43	1/8"-27NPTF	1/8"-28BSPT	4.90
02	HT7040-04-04	19.0	36.85	1/4"-18NPTF	1/4"-19BSPT	7.00
03	HT7040-04-08	24.0	28.00	1/4"-18NPTF	1/2"-14BSPT	13.50
04	HT7040-04-16	36.0	34.50	1/4"-18NPTF	1"-11BSPT	23.80
05	HT7040-06-06	22.0	36.57	3/8"-18NPTF	3/8"-19BSPT	10.30
06	HT7040-06-12	30.0	30.00	3/8"-18NPTF	3/4"-14BSPT	18.00
07	HT7040-08-08	30.0	47.50	1/2"-14NPTF	1/2"-14BSPT	13.50
08	HT7040-08-12	30.0	30.00	1/2"-14NPTF	3/4"-14BSPT	18.00
09	HT7040-12-12	36.0	50.00	3/4"-14NPTF	3/4"-14BSPT	18.00
10	HT7040-12-16	36.0	34.50	3/4"-14NPTF	1"-11BSPT	23.80
11	HT7040-16-16	41.0	60.20	1"-11-1/2NPTF	1"-11BSPT	23.80

ALL REQUIREMENT AS PER SAE J514 & DIN 3900

ALL DIMENSIONS ARE IN MM



[www.HYTECHGROUP.com](http://www.HYTECHGROUP.com)

World class

Hydraulic Fittings, Cylinders, Hoses & Precision Components  
ISO 9001-2008 Company



## CONVERSION FITTINGS - HT7042-00-00

### CONVERSION FITTINGS -

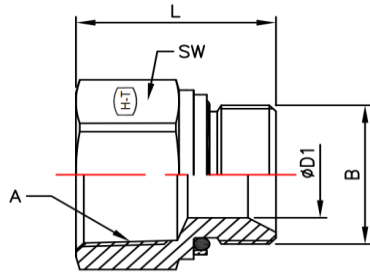

### FP-MBSPP Straight

SR. NO.	PART NO.	SW	L	A NPTF THREAD (INT)	B BSPP THREAD	ØD1
01	HT7042-02-02	17.0	28.00	1/8"-27NPTF	1/8"-28BSPP	3.50
02	HT7042-04-04	19.0	32.50	1/4"-18NPTF	1/4"-19BSPP	6.00
03	HT7042-04-06	22.0	21.50	1/4"-18NPTF	3/8"-19BSPP	10.99
04	HT7042-04-08	27.0	28.00	1/4"-18NPTF	1/2"-14BSPP	10.99
05	HT7042-04-12	32.0	28.00	1/4"-18NPTF	3/4"-14BSPP	10.99
06	HT7042-04-16	41.0	29.00	1/4"-18NPTF	1"-11BSPP	10.99
07	HT7042-06-04	22.0	32.90	3/8"-18NPTF	1/4"-19BSPP	6.00
08	HT7042-06-06	22.0	33.90	3/8"-18NPTF	3/8"-19BSPP	7.90
09	HT7042-06-08	27.0	42.40	3/8"-18NPTF	1/2"-14BSPP	11.10
10	HT7042-06-10	30.0	26.00	3/8"-18NPTF	5/8"-14BSPP	14.41
11	HT7042-06-12	32.0	28.00	3/8"-18NPTF	3/4"-14BSPP	14.41
12	HT7042-06-16	41.0	29.00	3/8"-18NPTF	1"-11BSPP	14.41
13	HT7042-08-04	30.0	39.00	1/2"-14NPTF	1/4"-19BSPP	6.00
14	HT7042-08-06	30.0	40.00	1/2"-14NPTF	3/8"-19BSPP	7.90
15	HT7042-08-08	30.0	44.50	1/2"-14NPTF	1/2"-14BSPP	11.10
16	HT7042-08-12	32.0	41.00	1/2"-14NPTF	3/4"-14BSPP	16.70
17	HT7042-08-16	41.0	29.00	1/2"-14NPTF	1"-11BSPP	17.81
18	HT7042-12-12	32.0	48.50	3/4"-14NPTF	3/4"-14BSPP	16.70
19	HT7042-12-16	41.0	50.50	3/4"-14NPTF	1"-11BSPP	22.20
20	HT7042-16-16	41.0	54.80	1"-11-1/2NPTF	1"-11BSPP	22.20

ALL REQUIREMENT AS PER SAE J514/ BS:5200

ALL DIMENSIONS ARE IN MM



[www.HYTECHGROUP.com](http://www.HYTECHGROUP.com)

World class

Hydraulic Fittings, Cylinders, Hoses & Precision Components  
ISO 9001-2008 Company



## CONVERSION FITTINGS - HT7062-00-00

### CONVERSION FITTINGS -

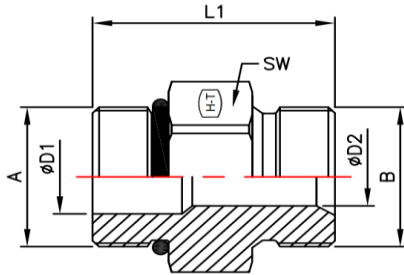

### MORB-MBSPP Straight

SR. NO.	PART NO.	SW	L	A UNF THREAD	ØD1	B BSPP THREAD	ØD2
01	HT7062-04-04	18.0	27.10	7/16"-20UNF	4.40	1/4"-19BSPP	4.70
02	HT7062-04-06	22.0	29.10	7/16"-20UNF	4.40	3/8"-19BSPP	7.90
03	HT7062-04-08	27.0	35.00	7/16"-20UNF	4.40	1/2"-14BSPP	11.10
04	HT7062-06-04	19.0	29.00	9/16"-18UNF	7.50	1/4"-19BSPP	4.70
05	HT7062-06-06	22.0	30.00	9/16"-18UNF	7.50	3/8"-19BSPP	7.90
06	HT7062-06-08	27.0	34.00	9/16"-18UNF	7.50	1/2"-14BSPP	11.10
07	HT7062-08-04	22.0	31.00	3/4"-16UNF	9.90	1/4"-19BSPP	4.70
08	HT7062-08-06	22.0	33.80	3/4"-16UNF	9.53	3/8"-19BSPP	9.53
09	HT7062-08-08	27.0	37.00	3/4"-16UNF	9.90	1/2"-14BSPP	11.10
10	HT7062-08-10	30.0	39.10	3/4"-16UNF	9.90	5/8"-14BSPP	14.30
11	HT7062-08-12	32.0	39.10	3/4"-16UNF	9.90	3/4"-14BSPP	16.70
12	HT7062-10-06	27.0	35.70	7/8"-14UNF	12.30	3/8"-19BSPP	7.90
13	HT7062-10-08	27.0	37.70	7/8"-14UNF	12.30	1/2"-14BSPP	11.10
14	HT7062-10-10	30.0	40.00	7/8"-14UNF	12.30	5/8"-14BSPP	14.30
15	HT7062-10-12	32.0	40.70	7/8"-14UNF	12.30	3/4"-14BSPP	16.70
16	HT7062-10-16	41.0	46.70	7/8"-14UNF	12.30	1"-11BSPP	22.20
17	HT7062-12-06	32.0	40.10	1-1/16"-12UN	15.50	3/8"-19BSPP	7.90
18	HT7062-12-08	32.0	42.10	1-1/16"-12UN	15.50	1/2"-14BSPP	11.10
19	HT7062-12-12	32.0	44.10	1-1/16"-12UN	15.50	3/4"-14BSPP	16.70
20	HT7062-12-16	41.0	49.10	1-1/16"-12UN	15.50	1"-11BSPP	22.20
21	HT7062-16-06	41.0	39.80	1-5/16"-12UN	21.40	3/8"-19BSPP	7.90
22	HT7062-16-12	41.0	44.90	1-5/16"-12UN	21.40	3/4"-14BSPP	16.70
23	HT7062-16-16	41.0	46.50	1-5/16"-12UN	21.40	1"-11BSPP	21.40

ALL REQUIREMENT AS PER SAE J514/ BS:5200

ALL DIMENSIONS ARE IN MM



[www.HYTECHGROUP.com](http://www.HYTECHGROUP.com)

World class

Hydraulic Fittings, Cylinders, Hoses & Precision Components  
ISO 9001-2008 Company



## CONVERSION FITTINGS - HT7100-00-00

CONVERSION FITTINGS -

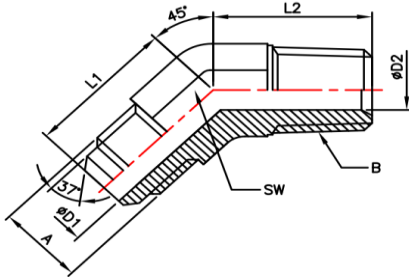

MJ-MBSPP 45° Elbow

SR. NO.	PART NO.	SW	A JIC THREAD	ØD1	L1	B BSPT THREAD	ØD2	L2
01	HT7100-06-04	14.0	9/16"-18UNF	7.50	21.00	1/4"-19BSPT	7.00	22.00
02	HT7100-06-06	19.0	9/16"-18UNF	7.50	21.00	3/8"-19BSPT	10.30	24.00
03	HT7100-08-06	19.0	3/4"-16UNF	9.90	25.00	3/8"-19BSPT	10.30	24.00
04	HT7100-08-08	22.0	3/4"-16UNF	9.90	25.00	1/2"-14BSPT	13.50	30.00
05	HT7100-10-08	22.0	7/8"-14UNF	12.30	28.00	1/2"-14BSPT	13.50	30.00
06	HT7100-12-12	27.0	1-1/16"-12UN	15.50	32.50	3/4"-14BSPT	18.00	30.50
07	HT7100-16-12	33.0	1-5/16"-12UN	21.50	37.50	3/4"-14BSPT	18.00	30.50
08	HT7100-16-16	33.0	1-5/16"-12UN	21.50	37.50	1"-11BSPT	23.80	37.50

ALL REQUIREMENT AS PER DIN 7631 / DIN 3852 / SAE J514

ALL DIMENSIONS ARE IN MM



[www.HYTECHGROUP.com](http://www.HYTECHGROUP.com)

World class

Hydraulic Fittings, Cylinders, Hoses & Precision Components  
ISO 9001-2008 Company



## CONVERSION FITTINGS - HT7102-00-00-NWO

### CONVERSION FITTINGS -

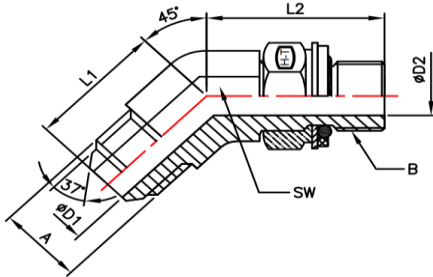

MJ-MBSPP ADJ. 45° Elbow

SR. NO.	PART NO.	SW	A JIC THREAD	ØD1	L1	B BSPP THREAD	ØD2	L2
01	HT7102-06-04-NWO	14.0	9/16"-18UNF	7.50	22.00	1/4"-19BSPP	7.50	29.00
02	HT7102-06-06-NWO	19.0	9/16"-18UNF	7.50	22.00	3/8"-19BSPP	9.90	33.00
03	HT7102-08-06-NWO	19.0	3/4"-16UNF	9.90	25.00	3/8"-19BSPP	9.90	33.00
04	HT7102-08-08-NWO	22.0	3/4"-16UNF	9.90	25.00	1/2"-14BSPP	12.30	38.50
05	HT7102-10-08-NWO	22.0	7/8"-14UNF	12.30	28.20	1/2"-14BSPP	12.30	38.60
06	HT7102-12-08-NWO	27.0	1-1/16"-12UN	15.50	32.50	1/2"-14BSPP	12.30	44.00
07	HT7102-12-12-NWO	27.0	1-1/16"-12UN	15.50	32.50	3/4"-14BSPP	15.50	44.00
08	HT7102-16-16-NWO	33.0	1-5/16"-12UN	21.50	37.50	1"-11BSPP	21.50	47.00

ALL REQUIREMENT AS PER SAE J514 /ISO 8434 /ISO 1179

ALL DIMENSIONS ARE IN MM





[www.HYTECHGROUP.com](http://www.HYTECHGROUP.com)

World class

Hydraulic Fittings, Cylinders, Hoses & Precision Components  
ISO 9001-2008 Company



## CONVERSION FITTINGS - HT7200-00-00

### CONVERSION FITTINGS -

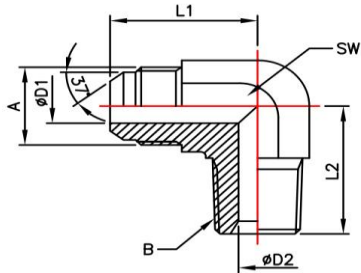

### MJ-MBSPP 90° Elbow

SR. NO.	PART NO.	SW	A JIC THREAD	ØD1	L1	B BSPT THREAD	ØD2	L2
01	HT7200-06-04	14.0	9/16"-18UNF	7.50	26.90	1/4"-19BSPT	7.00	27.70
02	HT7200-06-06	19.0	9/16"-18UNF	7.50	29.20	3/8"-19BSPT	10.30	31.00
03	HT7200-06-08	22.0	9/16"-18UNF	7.50	31.20	1/2"-14BSPT	13.50	37.50
04	HT7200-08-06	19.0	3/4"-16UNF	9.90	31.80	3/8"-19BSPT	10.30	31.00
05	HT7200-08-08	22.0	3/4"-16UNF	9.90	31.70	1/2"-14BSPT	13.50	37.50
06	HT7200-10-08	22.0	7/8"-14UNF	12.30	36.80	1/2"-14BSPT	13.50	37.50
07	HT7200-12-08	27.0	1-1/16"-12UN	15.50	42.20	1/2"-14BSPT	13.50	37.50
08	HT7200-12-12	27.0	1-1/16"-12UN	15.50	42.20	3/4"-14BSPT	18.30	40.50
09	HT7200-12-16	33.0	1-1/16"-12UN	15.50	46.00	1"-14BSPT	23.80	45.20
10	HT7200-16-12	33.0	1-5/16"-12UN	21.50	46.00	3/4"-14BSPT	18.30	40.50
11	HT7200-16-16	33.0	1-5/16"-12UN	21.50	46.00	1"-14BSPT	23.80	45.20

ALL REQUIREMENT AS PER SAE J514 /ISO 8434 /ISO 1179

ALL DIMENSIONS ARE IN MM



[www.HYTECHGROUP.com](http://www.HYTECHGROUP.com)

World class

Hydraulic Fittings, Cylinders, Hoses & Precision Components  
ISO 9001-2008 Company



## CONVERSION FITTINGS - HT7202-00-00-NWO

### CONVERSION FITTINGS -

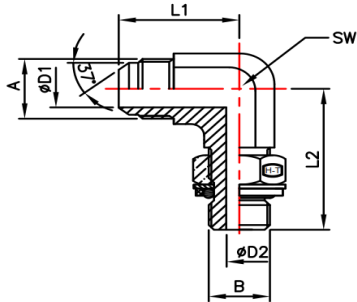

MJ-MBSPP ADJ. 90° Elbow

SR. NO.	PART NO.	SW	A JIC THREAD	ØD1	L1	B BSPP THREAD	ØD2	L2
01	HT7202-06-04-NWO	14.0	9/16"-18UNF	7.50	26.90	1/4"-19BSPP	7.50	32.00
02	HT7202-06-06-NWO	19.0	9/16"-18UNF	7.50	29.20	3/8"-19BSPP	9.90	37.00
03	HT7202-06-08-NWO	22.0	9/16"-18UNF	7.50	31.00	1/2"-14BSPP	12.30	43.00
04	HT7202-08-04-NWO	19.0	3/4"-16UNF	9.90	32.00	1/4"-19BSPP	7.50	37.00
05	HT7202-08-06-NWO	19.0	3/4"-16UNF	9.90	32.00	3/8"-19BSPP	9.90	37.00
06	HT7202-08-08-NWO	22.0	3/4"-16UNF	9.90	34.00	1/2"-14BSPP	12.30	43.00
07	HT7202-08-12-NWO	27.0	3/4"-16UNF	9.90	36.00	3/4"-14BSPP	15.50	49.28
08	HT7202-10-06-NWO	22.0	7/8"-14UNF	12.30	37.00	3/8"-19BSPP	9.90	36.00
09	HT7202-10-08-NWO	22.0	7/8"-14UNF	12.30	37.00	1/2"-14BSPP	12.30	43.00
10	HT7202-10-12-NWO	27.0	7/8"-14UNF	12.30	39.00	3/4"-14BSPP	15.50	49.50
11	HT7202-12-08-NWO	27.0	1-1/16"-12UN	15.50	42.00	1/2"-14BSPP	12.30	49.50
12	HT7202-12-12-NWO	27.0	1-1/16"-12UN	15.50	42.00	3/4"-14BSPP	15.50	49.50
13	HT7202-12-12-NWO	33.0	1-1/16"-12UN	15.50	45.00	1"-11BSPP	21.50	52.00
14	HT7202-16-12-NWO	33.0	1-5/16"-12UN	21.50	46.00	3/4"-14BSPP	15.50	49.50
15	HT7202-16-16-NWO	33.0	1-5/16"-12UN	21.50	46.00	1"-11BSPP	21.50	52.00
16	HT7202-20-24-NWO	50.0	1-5/8"-12UN	27.50	57.00	1-1/2"-11BSPP	33.00	60.00

ALL REQUIREMENT AS PER SAE J514 /ISO 8434 /ISO 1179

ALL DIMENSIONS ARE IN MM



[www.HYTECHGROUP.com](http://www.HYTECHGROUP.com)

World class

Hydraulic Fittings, Cylinders, Hoses & Precision Components  
ISO 9001-2008 Company



## CONVERSION FITTINGS - HT7204-00-00

### CONVERSION FITTINGS -

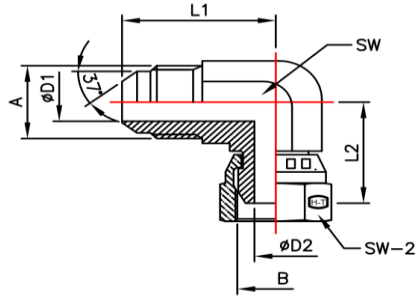

MJ-FBSPPS 90° Elbow

SR. NO.	PART NO.	SW	L1	A JIC THREAD	ØD1	L2	B BSPP THREAD (INT)	ØD2	SW-2
01	HT7204-04-04	14.00	22.60	7/16"-20UNF	4.40	26.1	1/4"-19BSPP	4.50	19.00
02	HT7204-06-06	19.00	26.90	9/16"-18UNF	7.50	27.0	3/8"-19BSPP	7.10	22.00
03	HT7204-08-06	19.00	31.80	3/4"-16UNF	9.90	27.0	3/8"-19BSPP	7.10	22.00
04	HT7204-08-08	22.00	31.80	3/4"-16UNF	9.90	32.3	1/2"-14BSPP	9.70	27.00
05	HT7204-12-12	27.00	42.20	1-1/16"-12UN	15.5	33.6	3/4"-14BSPP	15.5	32.00

ALL REQUIREMENT AS PER SAE J514 ,ISO8434 & BS:5200

ALL DIMENSIONS ARE IN MM



[www.HYTECHGROUP.com](http://www.HYTECHGROUP.com)

World class

Hydraulic Fittings, Cylinders, Hoses & Precision Components  
ISO 9001-2008 Company



## CONVERSION FITTINGS - HT7205-00-00-NWO

### CONVERSION FITTINGS -

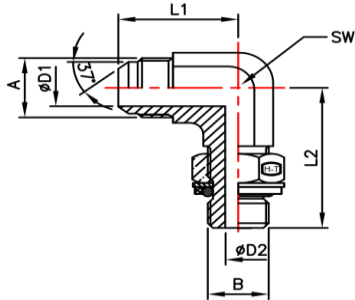

MJ-MM ADJ. 90° Elbow

SR. NO.	PART NO.	SW	A JIC THREAD	ØD1	L1	B BSPP THREAD	ØD2	L2
01	HT7205-06-12-NWO	14.0	9/16"-18UNF	7.50	26.90	M12X1.5 6g	6.00	32.50
02	HT7205-06-14-NWO	14.0	9/16"-18UNF	7.50	26.90	M14X1.5 6g	7.50	34.00
03	HT7205-06-16-NWO	19.0	9/16"-18UNF	7.50	29.20	M16X1.5 6g	9.00	37.50
04	HT7205-06-18-NWO	19.0	9/16"-18UNF	7.50	32.00	M18X1.5 6g	11.00	37.00
05	HT7205-08-16-NWO	19.0	3/4"-16UNF	9.90	32.00	M16X1.5 6g	9.00	37.00
06	HT7205-08-18-NWO	19.0	3/4"-16UNF	9.90	32.00	M18X1.5 6g	11.00	37.00
07	HT7205-08-20-NWO	22.0	3/4"-16UNF	9.90	34.00	M20X1.5 6g	10.00	41.50
08	HT7205-08-22-NWO	22.0	3/4"-16UNF	9.90	34.00	M22X1.5 6g	14.00	42.50
09	HT7205-10-18-NWO	22.0	7/8"-14UNF	12.30	37.00	M18X1.5 6g	11.00	41.00
10	HT7205-10-20-NWO	22.0	7/8"-14UNF	12.30	37.00	M20X1.5 6g	10.00	41.50
11	HT7205-10-22-NWO	22.0	7/8"-14UNF	12.30	37.00	M22X1.5 6g	14.00	42.50
12	HT7205-12-22-NWO	27.0	1-1/16"-12UN	15.50	42.20	M22X1.5 6g	14.00	44.00
13	HT7205-12-26-NWO	27.0	1-1/16"-12UN	15.50	42.20	M26X1.5 6g	18.00	50.00
14	HT7205-12-27-NWO	27.0	1-1/16"-12UN	15.50	42.20	M27X2.0 6g	18.00	50.00
15	HT7205-16-27-NWO	33.0	1-5/16"-12UN	21.50	46.00	M27X2.0 6g	18.00	53.00
16	HT7205-16-33-NWO	33.0	1-5/16"-12UN	21.50	46.00	M33X2.0 6g	23.00	53.00

ALL REQUIREMENT AS PER SAE J514 /ISO 6149-3

ALL DIMENSIONS ARE IN MM



[www.HYTECHGROUP.com](http://www.HYTECHGROUP.com)

World class

Hydraulic Fittings, Cylinders, Hoses & Precision Components  
ISO 9001-2008 Company



## CONVERSION FITTINGS - HTD8003-L00

[CONVERSION FITTINGS -](#)

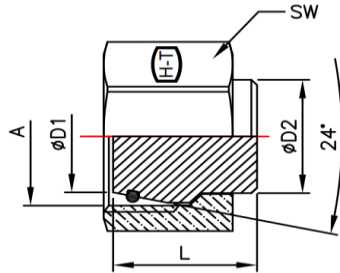

### METRIC LIGHT SERIES TUBE CAP

SR. NO.	PART NO.	SW	A THREAD MM (INT)	L	ØD1	ØD2
01	HTD8003-L06		M12X1.5 6H	18.50	5.69	6.00
02	HTD8003-L08		M14X1.5 6H	18.50	7.70	8.00
03	HTD8003-L10		M16X1.5 6H	20.00	9.60	10.00
04	HTD8003-L12		M18X1.5 6H	20.50	11.81	12.00
05	HTD8003-L16		M22X1.5 6H	20.50	14.60	15.00
06	HTD8003-L18		M26X1.5 6H	22.50	17.70	18.00
07	HTD8003-L22		M30X2.0 6H	25.00	21.70	22.00
08	HTD8003-L28		M36X2.0 6H	25.50	27.70	28.00
09	HTD8003-L35		M45X2.0 6H	30.00	33.99	35.00
10	HTD8003-L42		M52X2.0 6H	30.00	42.33	42.00

ALL REQUIREMENT AS PER SAE J514 & BS:5200

ALL DIMENSIONS ARE IN MM



[www.HYTECHGROUP.com](http://www.HYTECHGROUP.com)

World class

Hydraulic Fittings, Cylinders, Hoses & Precision Components  
ISO 9001-2008 Company



## CONVERSION FITTINGS - HTD8003-S00

### CONVERSION FITTINGS -

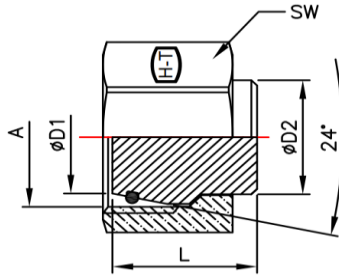

### METRIC HEAVY SERIES TUBE CAP

SR. NO.	PART NO.	SW	A THREAD MM (INT)	L	ØD1	ØD2
01	HTD8003-S06		M14X1.5 6H	18.50	5.69	6.00
02	HTD8003-S08		M16X1.5 6H	18.50	7.70	8.00
03	HTD8003-S10		M18X1.5 6H	20.00	9.60	10.00
04	HTD8003-S12		M20X1.5 6H	20.50	11.60	12.00
05	HTD8003-S14		M22X1.5 6H	22.50	13.50	14.00
06	HTD8003-S16		M24X1.5 6H	23.50	15.20	16.00
07	HTD8003-S20		M30X2.0 6H	28.50	18.90	20.00
08	HTD8003-S25		M36X2.0 6H	29.00	23.30	25.00
09	HTD8003-S30		M45X2.0 6H	30.50	27.80	30.00
10	HTD8003-S38		M52X2.0 6H	33.00	35.50	38.00

ALL REQUIREMENT AS PER SAE J514 & BS:5200

ALL DIMENSIONS ARE IN MM



[www.HYTECHGROUP.com](http://www.HYTECHGROUP.com)

World class

Hydraulic Fittings, Cylinders, Hoses & Precision Components  
ISO 9001-2008 Company



## CONVERSION FITTINGS - HT8055-00-00

### CONVERSION FITTINGS -

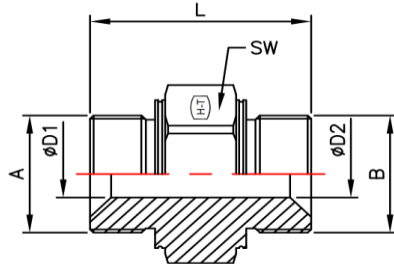

### MM-MM (Metric Nipple)

S.R. NO.	PART NO.	SW	L	A MM THREAD	ØD1	B MM THREAD	ØD2
01	HT8055-10-10	14.0	28.00	M10X1.0 6g	3.00	M10X1.0 6g	3.00
02	HT8055-12-12	17.0	37.50	M12X1.5 6g	6.00	M12X1.5 6g	6.00
03	HT8055-14-14	19.0	38.50	M14X1.5 6g	7.50	M14X1.5 6g	7.50
04	HT8055-16-16	22.0	41.50	M16X1.5 6g	9.00	M16X1.5 6g	9.00
05	HT8055-18-18	24.0	42.50	M18X1.5 6g	11.00	M18X1.5 6g	11.00
06	HT8055-20-20	27.0	46.50	M20X1.5 6g	12.50	M20X1.5 6g	12.50
07	HT8055-22-22	27.0	46.50	M22X1.5 6g	14.00	M22X1.5 6g	14.00
08	HT8055-24-24	30.0	48.50	M24X1.5 6g	14.00	M24X1.5 6g	14.00
09	HT8055-26-26	32.0	53.50	M26X1.5 6g	18.00	M26X1.5 6g	18.00
10	HT8055-30-30	36.0	56.00	M30X2.0 6g	21.00	M30X2.0 6g	21.00
11	HT8055-12-10	17.0	33.00	M12X1.5 6g	6.00	M10X1.0 6g	3.50
12	HT8055-14-12	19.0	37.00	M14X1.5 6g	7.50	M12X1.5 6g	6.00
13	HT8055-16-12	22.0	41.00	M16X1.5 6g	9.00	M12X1.5 6g	6.00
14	HT8055-16-14	22.0	41.00	M16X1.5 6g	9.00	M14X1.5 6g	7.50
15	HT8055-18-16	24.0	41.00	M18X1.5 6g	11.00	M16X1.5 6g	9.00
16	HT8055-20-18	27.0	43.00	M20X1.5 6g	12.50	M18X1.5 6g	11.00
17	HT8055-22-16	27.0	45.00	M22X1.5 6g	14.00	M16X1.5 6g	9.00
18	HT8055-22-18	27.0	45.00	M22X1.5 6g	14.00	M18X1.5 6g	11.00
19	HT8055-24-20	30.0	47.00	M24X1.5 6g	15.50	M20X1.5 6g	12.50
20	HT8055-24-22	30.0	47.00	M24X1.5 6g	15.50	M22X1.5 6g	14.00
21	HT8055-26-18	32.0	47.00	M26X1.5 6g	18.00	M18X1.5 6g	11.00
22	HT8055-26-22	32.0	49.00	M26X1.5 6g	18.00	M22X1.5 6g	14.00

ALL REQUIREMENT AS PER DIN 7631 & ISO 6149-3

ALL DIMENSIONS ARE IN MM



[www.HYTECHGROUP.com](http://www.HYTECHGROUP.com)

World class

Hydraulic Fittings, Cylinders, Hoses & Precision Components  
ISO 9001-2008 Company



## CONVERSION FITTINGS - HT8555-H-00-O

[CONVERSION FITTINGS -](#)

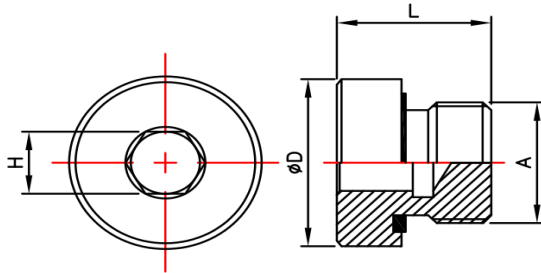

MM Hollow Hex Plug

SR. NO.	PART NO.	ØD	METRIC THREAD	L	H
01	HT8555-H10-O	14.0	M10X1.0 6g	12.30	5.00
02	HT8555-H12-O	17.0	M12X1.5 6g	17.30	6.00
03	HT8555-H14-O	19.0	M14X1.5 6g	17.30	6.00
04	HT8555-H16-O	22.0	M16X1.5 6g	17.30	8.00
05	HT8555-H18-O	24.0	M18X1.5 6g	17.30	8.00
06	HT8555-H20-O	26.0	M20X1.5 6g	19.30	10.00
07	HT8555-H22-O	27.0	M22X1.5 6g	19.30	10.00
08	HT8555-H26-O	32.0	M26X1.5 6g	21.30	12.00
09	HT8555-H27-O	32.0	M27X2.0 6g	21.30	12.00
10	HT8555-H33-O	40.0	M33X2.0 6g	22.80	17.00
11	HT8555-H42-O	50.0	M42X2.0 6g	22.80	22.00
12	HT8555-H48-O	55.0	M48X2.0 6g	22.80	24.00

ALL REQUIREMENT AS PER ISO 9974-4

ALL DIMENSIONS ARE IN MM





[www.HYTECHGROUP.com](http://www.HYTECHGROUP.com)

World class

Hydraulic Fittings, Cylinders, Hoses & Precision Components  
ISO 9001-2008 Company



## CONVERSION FITTINGS - HT8555-P-00

[CONVERSION FITTINGS -](#)

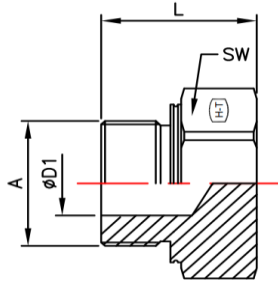

### Metric Hex Plug (ISO6149)

SR. NO.	PART NO.	SW	A THREAD MM (INT)	L	ØD1
01	HT8555-P-08	12.0	M8X1.0 6g	15.00	3.00
02	HT8555-P-10	14.0	M10X1.0 6g	16.00	4.50
03	HT8555-P-12	17.0	M12X1.5 6g	20.00	6.00
04	HT8555-P-14	19.0	M14X1.5 6g	20.00	7.50
05	HT8555-P-16	22.0	M16X1.5 6g	22.00	9.00
06	HT8555-P-18	24.0	M18X1.5 6g	23.00	11.00
07	HT8555-P-20	27.0	M20X1.5 6g	25.00	12.00
08	HT8555-P-22	27.0	M22X1.5 6g	26.00	14.00
09	HT8555-P-24	27.0	M24X1.5 6g	26.00	15.00
10	HT8555-P-26	32.0	M26X1.5 6g	29.00	16.00
11	HT8555-P-27	32.0	M27X2.0 6g	29.00	18.00
12	HT8555-P-30	36.0	M30X2.0 6g	33.00	21.00
13	HT8555-P-33	41.0	M33X2.0 6g	34.00	23.00
14	HT8555-P-42	50.0	M42X2.0 6g	36.00	30.00
15	HT8555-P-48	55.0	M48X2.0 6g	37.00	36.00

ALL REQUIREMENT AS PER ISO 9974 & ISO 6149

ALL DIMENSIONS ARE IN MM



[www.HYTECHGROUP.com](http://www.HYTECHGROUP.com)

World class

Hydraulic Fittings, Cylinders, Hoses & Precision Components  
ISO 9001-2008 Company



## CONVERSION FITTINGS - HT8800-00

[CONVERSION FITTINGS -](#)

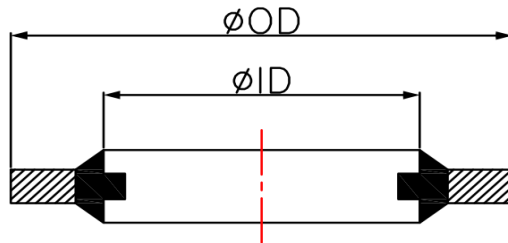

### Self Centering Bonded Seal Metric

SR. NO.	PART NO.	PART DESCRIPTION	ID	OD
01	HT8800-06	6MM SELF CENTERING BONDED SEAL	6.70	10.00
02	HT8800-08	8MM SELF CENTERING BONDED SEAL	8.70	14.00
03	HT8800-10	10MM SELF CENTERING BONDED SEAL	10.70	16.00
04	HT8800-12	12MM SELF CENTERING BONDED SEAL	12.70	18.00
05	HT8800-14	14MM SELF CENTERING BONDED SEAL	14.70	22.00
06	HT8800-16	16MM SELF CENTERING BONDED SEAL	16.70	24.00
07	HT8800-18	18MM SELF CENTERING BONDED SEAL	18.70	26.00
08	HT8800-20	20MM SELF CENTERING BONDED SEAL	20.70	28.00
09	HT8800-22	22MM SELF CENTERING BONDED SEAL	22.70	30.00
10	HT8800-24	24MM SELF CENTERING BONDED SEAL	24.70	32.00
11	HT8800-26	26MM SELF CENTERING BONDED SEAL	26.70	35.00
12	HT8800-30	30MM SELF CENTERING BONDED SEAL	33.00	39.00

ALL REQUIREMENT AS PER SAE J514 & BS:5200

ALL DIMENSIONS ARE IN MM



[www.HYTECHGROUP.com](http://www.HYTECHGROUP.com)

World class

Hydraulic Fittings, Cylinders, Hoses & Precision Components  
ISO 9001-2008 Company



## CONVERSION FITTINGS - HT9000-00-00

### CONVERSION FITTINGS -

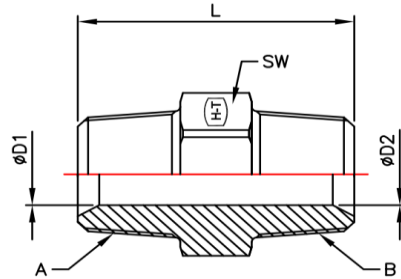

### MBSPT-MBSPT Straight

SR. NO.	PART NO.	SW	L	A BSPT THREAD	ØD1	B BSPT THREAD	ØD2
01	HT9000-02-02	11.0	26.00	1/8"-28 BSPT	4.90	1/8"-28 BSPT	4.90
02	HT9000-04-04	14.0	35.80	1/4"-19BSPT	7.00	1/4"-19BSPT	7.00
03	HT9000-06-04	19.0	35.80	3/8"-19BSPT	10.30	1/4"-19BSPT	7.00
04	HT9000-06-06	19.0	35.80	3/8"-19BSPT	10.30	3/8"-19BSPT	10.30
05	HT9000-08-04	22.0	42.10	1/2"-14BSPT	12.70	1/4"-19BSPT	7.00
06	HT9000-08-06	22.0	43.20	1/2"-14BSPT	12.70	3/8"-19BSPT	10.30
07	HT9000-08-08	22.0	48.00	1/2"-14BSPT	12.70	1/2"-14BSPT	12.70
08	HT9000-10-10	27.0	53.70	5/8"-14BSPT	15.00	5/8"-14BSPT	15.00
09	HT9000-12-08	27.0	48.70	3/4"-14BSPT	18.00	1/2"-14BSPT	12.70
10	HT9000-12-12	27.0	50.00	3/4"-14BSPT	18.00	3/4"-14BSPT	18.00
11	HT9000-16-12	36.0	53.60	1"-11BSPT	23.80	3/4"-14BSPT	18.00
12	HT9000-16-16	36.0	59.00	1"-11BSPT	23.80	1"-11BSPT	23.80

ALL REQUIREMENT AS PER DIN 3900

ALL DIMENSIONS ARE IN MM



[www.HYTECHGROUP.com](http://www.HYTECHGROUP.com)

World class

Hydraulic Fittings, Cylinders, Hoses & Precision Components  
ISO 9001-2008 Company



## CONVERSION FITTINGS - HT9001-00-00

### CONVERSION FITTINGS -

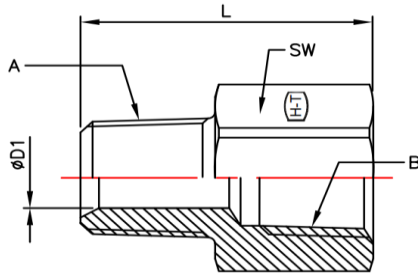

### MBSPT-FMSPT Straight

SR. NO.	PART NO.	SW	L	A BSPT THREAD	ØD1	B BSPT THREAD (INT)
01	HT9001-06-04	19.0	25.80	3/8"-19BSPT	6.00	1/4"-19BSPT
02	HT9001-08-04	22.0	28.00	1/2"-14BSPT	6.00	1/4"-19BSPT
03	HT9001-08-06	22.0	28.00	1/2"-14BSPT	9.00	3/8"-19BSPT
04	HT9001-12-06	27.0	31.00	3/4"-14BSPT	9.00	3/8"-19BSPT
05	HT9001-12-08	30.0	30.13	3/4"-14BSPT	13.00	1/2"-14BSPT
06	HT9001-16-08	36.0	35.50	1"-14BSPT	13.00	1/2"-14BSPT
07	HT9001-16-12	36.0	34.50	1"-14BSPT	18.00	3/4"-14BSPT

ALL REQUIREMENT AS PER SAE DIN 3900

ALL DIMENSIONS ARE IN MM



[www.HYTECHGROUP.com](http://www.HYTECHGROUP.com)

World class

Hydraulic Fittings, Cylinders, Hoses & Precision Components

ISO 9001-2008 Company



## CONVERSION FITTINGS - HT9020-00-00

### CONVERSION FITTINGS -

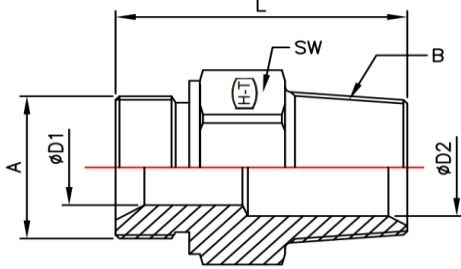

### MBSPP-MBSPT Straight

S.R. NO.	PART NO.	SW	L	A BSPP THREAD	ØD1	B BSPT THREAD	ØD2
01	HT9020-04-04	19.0	32.70	1/4"-19BSPP	4.70	1/4"-19BSPT	7.00
02	HT9020-04-06	19.0	34.50	1/4"-19BSPP	4.70	3/8"-19BSPT	10.30
03	HT9020-04-08	22.0	40.00	1/4"-19BSPP	4.70	1/2"-14BSPT	13.50
04	HT9020-06-04	22.0	34.70	3/8"-19BSPP	7.90	1/4"-19BSPT	7.00
05	HT9020-06-06	22.0	36.00	3/8"-19BSPP	7.90	3/8"-19BSPT	10.30
06	HT9020-06-08	22.0	41.00	3/8"-19BSPP	7.90	1/2"-14BSPT	13.50
07	HT9020-06-12	27.0	43.00	3/8"-19BSPP	7.90	3/4"-14BSPT	18.00
08	HT9020-06-16	36.0	50.90	3/8"-19BSPP	7.90	1"-11BSPT	23.80
09	HT9020-08-04	27.0	38.70	1/2"-14BSPP	11.10	1/4"-19BSPT	7.00
10	HT9020-08-06	27.0	38.20	1/2"-14BSPP	11.10	3/8"-19BSPT	10.30
11	HT9020-08-08	27.0	43.50	1/2"-14BSPP	11.10	1/2"-14BSPT	13.50
12	HT9020-08-10	30.0	45.00	1/2"-14BSPP	11.10	5/8"-14BSPT	15.00
13	HT9020-08-12	27.0	45.00	1/2"-14BSPP	11.10	3/4"-14BSPT	18.00
14	HT9020-10-06	30.0	42.00	5/8"-14BSPP	14.30	3/8"-19BSPT	10.30
15	HT9020-10-08	30.0	47.00	5/8"-14BSPP	14.30	1/2"-14BSPT	13.50
16	HT9020-10-10	30.0	47.00	5/8"-14BSPP	14.30	5/8"-14BSPT	15.00
17	HT9020-10-12	30.0	47.00	5/8"-14BSPP	14.30	3/4"-14BSPT	18.00
18	HT9020-12-04	32.0	42.20	3/4"-14BSPP	16.70	1/4"-19BSPT	7.00
19	HT9020-12-06	32.0	42.20	3/4"-14BSPP	16.70	3/8"-19BSPT	10.30
20	HT9020-12-08	32.0	47.00	3/4"-14BSPP	16.70	1/2"-14BSPT	13.50
21	HT9020-12-12	32.0	47.50	3/4"-14BSPP	16.70	3/4"-14BSPT	18.00
22	HT9020-12-16	36.0	54.90	3/4"-14BSPP	16.70	1"-11BSPT	23.80
23	HT9020-16-08	41.0	52.00	1"-11BSPP	22.20	1/2"-14BSPT	13.50
24	HT9020-16-12	41.0	52.00	1"-11BSPP	22.20	3/4"-14BSPT	18.00
25	HT9020-16-16	41.0	56.00	1"-11BSPP	22.20	1"-11BSPT	23.80

ALL REQUIREMENT AS PER BS:5200 / ISO:8434-6 / DIN 3900

ALL DIMENSIONS ARE IN MM



[www.HYTECHGROUP.com](http://www.HYTECHGROUP.com)

World class

Hydraulic Fittings, Cylinders, Hoses & Precision Components

ISO 9001-2008 Company



## CONVERSION FITTINGS - HT9022-00-00

### CONVERSION FITTINGS -

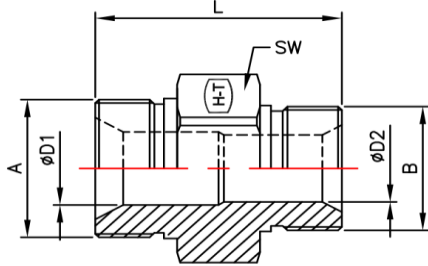

### MBSPP-MBSPP Straight

SR. NO.	PART NO.	SW	L	A BSPP THREAD	ØD1	B BSPT THREAD	ØD2
01	HT9022-04-02	19.0	29.50	1/4"-19BSPP	4.70	1/8"-19BSPP	3.50
02	HT9022-04-04	19.0	33.00	1/4"-19BSPP	4.70	1/4"-19BSPP	4.70
03	HT9022-06-04	22.0	35.50	3/8"-19BSPP	7.90	1/4"-19BSPP	4.70
04	HT9022-06-06	22.0	37.00	3/8"-19BSPP	7.90	3/8"-19BSPP	7.90
05	HT9022-08-04	27.0	40.00	1/2"-14BSPP	11.10	1/4"-19BSPP	4.70
06	HT9022-08-06	27.0	41.50	1/2"-14BSPP	11.10	3/8"-19BSPP	7.90
07	HT9022-08-08	27.0	44.00	1/2"-14BSPP	11.10	1/2"-14BSPP	11.10
08	HT9022-10-04	30.0	44.00	5/8"-14BSPP	14.30	1/4"-19BSPP	4.70
09	HT9022-10-06	30.0	45.50	5/8"-14BSPP	14.30	3/8"-19BSPP	7.90
10	HT9022-10-08	30.0	48.00	5/8"-14BSPP	14.30	1/2"-14BSPP	11.10
11	HT9022-10-10	30.0	50.00	5/8"-14BSPP	14.30	5/8"-14BSPP	14.30
12	HT9022-12-04	32.0	44.00	3/4"-14BSPP	16.70	1/4"-19BSPP	4.70
13	HT9022-12-06	32.0	45.50	3/4"-14BSPP	16.70	3/8"-19BSPP	7.90
14	HT9022-12-08	32.0	48.00	3/4"-14BSPP	16.70	1/2"-14BSPP	11.10
15	HT9022-12-10	32.0	50.00	3/4"-14BSPP	16.70	5/8"-14BSPP	14.30
16	HT9022-12-12	32.0	51.20	3/4"-14BSPP	16.70	3/4"-14BSPP	16.70
17	HT9022-16-04	41.0	50.00	1"-11BSPP	22.20	1/4"-19BSPP	4.70
18	HT9022-16-06	41.0	51.50	1"-11BSPP	22.20	3/8"-19BSPP	7.90
19	HT9022-16-08	41.0	54.00	1"-11BSPP	22.20	1/2"-14BSPP	11.10
20	HT9022-16-10	41.0	56.00	1"-11BSPP	22.20	5/8"-14BSPP	14.30
21	HT9022-16-12	41.0	56.00	1"-11BSPP	22.20	3/4"-14BSPP	16.70
22	HT9022-16-16	41.0	59.00	1"-11BSPP	22.20	1"-11BSPP	22.20
23	HT9022-20-12	50.0	55.00	1-1/4"11BSPP	28.60	3/4"-14BSPP	16.70
24	HT9022-24-16	55.0	64.00	1-1/2"11BSPP	33.30	1"-11BSPP	22.20

ALL REQUIREMENT AS PER BS:5200 / ISO:8434-6

ALL DIMENSIONS ARE IN MM



[www.HYTECHGROUP.com](http://www.HYTECHGROUP.com)

World class

Hydraulic Fittings, Cylinders, Hoses & Precision Components  
ISO 9001-2008 Company



## CONVERSION FITTINGS - HT9023-00-00

CONVERSION FITTINGS -

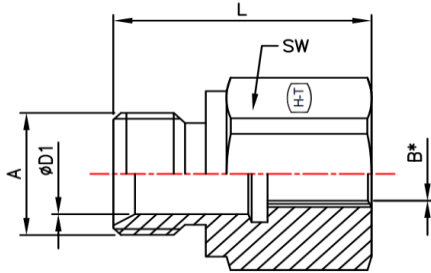

### MBSPP-FBSPP Straight

SR. NO.	PART NO.	SW	L	A BSPT THREAD	ØD1	B BSPT THREAD (INT)
01	HT9023-08-04	27.0	38.00	1/2"-14BSPT	11.10	1/4"-19BSPP
02	HT9023-12-04	32.0	40.00	3/4"-14BSPT	16.70	1/4"-19BSPP
03	HT9023-12-06	32.0	42.00	3/4"-14BSPT	16.70	3/8"-19BSPP
04	HT9023-16-04	41.0	43.00	1"-14BSPT	22.20	1/4"-19BSPP
05	HT9023-16-06	41.0	45.00	1"-14BSPT	22.20	3/8"-19BSPP
06	HT9023-16-08	41.0	51.00	1"-14BSPT	22.20	1/2"-14BSPP

\* THIS THREADED ARE CAPABLE FOR BSPP MALE & BSPT MALE ALSO  
ALL REQUIREMENT AS PER ISO 8434, ISO 1179-1, BS 5200, DIN 3852  
ALL DIMENSIONS ARE IN MM



[www.HYTECHGROUP.com](http://www.HYTECHGROUP.com)

World class

Hydraulic Fittings, Cylinders, Hoses & Precision Components  
ISO 9001-2008 Company



## CONVERSION FITTINGS - HT9024-00-00

### CONVERSION FITTINGS -

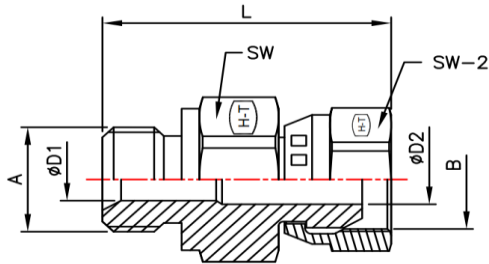

### MBSP-BSPPS Straight

SR. NO.	PART NO.	SW	L	L1	A		B		ØD2	SW-2
					UNF THREAD (INT)	ØD1	BSPP THREAD (INT)	ØD2		
01	HT9024-04-04	19.00	34.50	31.80	1/4"-19BSPP	4.70	1/4"-19BSPP	4.50	19.00	
02	HT9024-04-06	19.00	37.00	33.00	1/4"-19BSPP	4.70	3/8"-19BSPP	7.10	22.00	
03	HT9024-04-08	22.00	42.50	38.00	1/4"-19BSPP	4.70	1/2"-14BSPP	9.70	27.00	
04	HT9024-06-04	22.00	37.00	34.30	3/8"-19BSPP	7.90	1/4"-19BSPP	4.50	19.00	
05	HT9024-06-06	22.00	39.60	35.50	3/8"-19BSPP	7.90	3/8"-19BSPP	7.10	22.00	
06	HT9024-06-08	22.00	43.50	39.50	3/8"-19BSPP	7.90	1/2"-14BSPP	9.70	27.00	
07	HT9024-06-12	27.00	48.70	42.50	3/8"-19BSPP	7.90	3/4"-14BSPP	15.50	32.00	
08	HT9024-08-04	27.00	40.70	38.50	1/2"-14BSPP	11.10	1/4"-19BSPP	4.50	19.00	
09	HT9024-08-06	27.00	43.00	40.00	1/2"-14BSPP	11.10	3/8"-19BSPP	7.10	22.00	
10	HT9024-08-08	27.00	46.00	42.50	1/2"-14BSPP	11.10	1/2"-14BSPP	9.70	27.00	
11	HT9024-08-10	27.00	50.20	43.50	1/2"-14BSPP	11.10	5/8"-14BSPP	12.00	30.00	
12	HT9024-08-12	27.00	51.20	45.50	1/2"-14BSPP	11.10	3/4"-14BSPP	15.50	32.00	
13	HT9024-08-16	32.00	58.70	53.00	1/2"-14BSPP	11.10	1"-11BSPP	20.40	41.00	
14	HT9024-10-08	30.00	49.50	46.00	5/8"-14BSPP	14.30	1/2"-14BSPP	9.70	27.00	
15	HT9024-10-10	30.00	53.00	46.30	5/8"-14BSPP	14.30	5/8"-14BSPP	12.00	30.00	
16	HT9024-10-12	30.00	52.70	47.00	5/8"-14BSPP	14.30	3/4"-14BSPP	15.50	32.00	
17	HT9024-12-06	32.00	46.50	43.50	3/4"-14BSPP	16.70	3/8"-19BSPP	7.10	22.00	
18	HT9024-12-08	32.00	50.00	46.50	3/4"-14BSPP	16.70	1/2"-14BSPP	9.70	27.00	
19	HT9024-12-10	32.00	52.20	45.50	3/4"-14BSPP	16.70	5/8"-14BSPP	12.00	30.00	
20	HT9024-12-12	32.00	53.50	47.30	3/4"-14BSPP	16.70	3/4"-14BSPP	15.50	32.00	
21	HT9024-12-16	33.00	63.00	55.50	3/4"-14BSPP	16.70	1"-11BSPP	20.40	41.00	
22	HT9024-16-08	41.00	54.50	51.00	1"-11BSPP	22.20	1/2"-14BSPP	9.70	27.00	
23	HT9024-16-10	41.00	57.20	50.50	1"-11BSPP	22.20	5/8"-14BSPP	12.00	30.00	
24	HT9024-16-12	41.00	57.70	52.00	1"-11BSPP	22.20	3/4"-14BSPP	15.50	32.00	
25	HT9024-16-16	41.00	66.00	58.50	1"-11BSPP	22.20	1"-11BSPP	20.40	41.00	

ALL REQUIREMENT AS PER BS:5200 & ISO:8434

ALL DIMENSIONS ARE IN MM





[www.HYTECHGROUP.com](http://www.HYTECHGROUP.com)

World class

Hydraulic Fittings, Cylinders, Hoses & Precision Components

ISO 9001-2008 Company



## CONVERSION FITTINGS - HT9025-00-00

### CONVERSION FITTINGS -

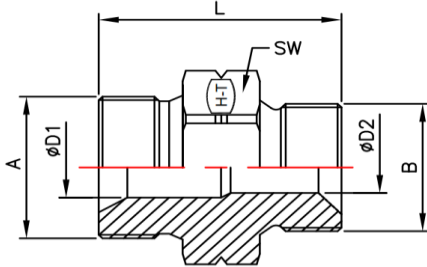

### MBSPP-MM Straight

S.R. NO.	PART NO.	SW	L	A BSPP THREAD	ØD1	B BSPP THREAD	ØD2
01	HT9025-04-12	19.0	30.00	1/4"-19BSPP	4.70	M12X1.5 6g	6.00
02	HT9025-04-14	19.0	30.00	1/4"-19BSPP	4.70	M14X1.5 6g	7.50
03	HT9025-04-16	22.0	30.00	1/4"-19BSPP	4.70	M16X1.5 6g	9.00
04	HT9025-04-18	24.0	31.50	1/4"-19BSPP	4.70	M18X1.5 6g	11.00
05	HT9025-04-22	27.0	37.00	1/4"-19BSPP	4.70	M22X1.5 6g	14.00
17	HT9025-06-12	22.0	32.00	3/8"-19BSPP	7.90	M12X1.5 6g	6.00
18	HT9025-06-14	22.0	32.00	3/8"-19BSPP	7.90	M14X1.5 6g	7.50
06	HT9025-06-16	22.0	32.00	3/8"-19BSPP	7.90	M16X1.5 6g	9.00
07	HT9025-06-18	24.0	32.50	3/8"-19BSPP	7.90	M18X1.5 6g	11.00
08	HT9025-06-20	27.0	33.00	3/8"-19BSPP	7.90	M20X1.5 6g	12.50
09	HT9025-06-22	27.0	38.00	3/8"-19BSPP	7.90	M22X1.5 6g	14.00
19	HT9025-08-12	27.0	36.00	1/2"-14BSPP	11.10	M12X1.5 6g	6.00
20	HT9025-08-14	27.0	36.00	1/2"-14BSPP	11.10	M14X1.5 6g	7.50
21	HT9025-08-16	27.0	36.00	1/2"-14BSPP	11.10	M16X1.5 6g	9.00
22	HT9025-08-18	27.0	38.00	1/2"-14BSPP	11.10	M18X1.5 6g	11.00
10	HT9025-08-20	27.0	38.00	1/2"-14BSPP	11.10	M20X1.5 6g	12.50
11	HT9025-08-22	27.0	40.00	1/2"-14BSPP	11.10	M22X1.5 6g	14.00
12	HT9025-08-24	30.0	40.00	1/2"-14BSPP	11.10	M24X1.5 6g	15.50
13	HT9025-08-26	32.0	42.00	1/2"-14BSPP	11.10	M26X1.5 6g	18.00
23	HT9025-10-22	30.0	42.00	5/8"-14BSPP	14.30	M22X1.5 6g	14.00
14	HT9025-10-26	32.0	44.00	5/8"-14BSPP	14.30	M26X1.5 6g	18.00
15	HT9025-12-26	32.0	44.00	3/4"-14BSPP	16.70	M26X1.5 6g	18.00
16	HT9025-12-30	36.0	46.00	3/4"-14BSPP	16.70	M30X2.0 6g	21.00
24	HT9025-12-16	32.0	40.00	3/4"-14BSPP	16.70	M16X1.5 6g	9.00
25	HT9025-12-18	32.0	40.00	3/4"-14BSPP	16.70	M18X1.5 6g	11.00

ALL REQUIREMENT AS PER SAE J514/ BS:5200

ALL DIMENSIONS ARE IN MM



[www.HYTECHGROUP.com](http://www.HYTECHGROUP.com)

World class

Hydraulic Fittings, Cylinders, Hoses & Precision Components  
ISO 9001-2008 Company



## CONVERSION FITTINGS - HT9025-00-00

CONVERSION FITTINGS -

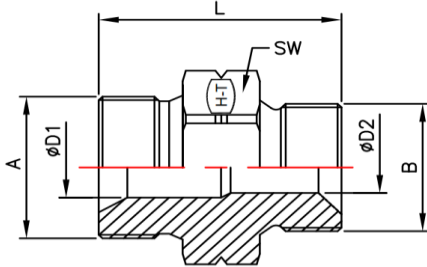

### MBSPP-MM Straight

SR. NO.	PART NO.	SW	L	A BSPP THREAD	ØD1	B BSPP THREAD	ØD2
26	HT9025-12-20	32.0	42.00	3/4"-14BSPP	16.70	M20X1.5 6g	12.50
27	HT9025-12-22	32.0	42.00	3/4"-14BSPP	16.70	M22X1.5 6g	14.00
28	HT9025-12-24	32.0	42.00	3/4"-14BSPP	16.70	M24X1.5 6g	15.50
29	HT9025-16-18	41.0	46.00	1"11BSPP	22.20	M18X1.5 6g	11.00
30	HT9025-16-22	41.0	48.00	1"11BSPP	22.20	M22X1.5 6g	14.00
31	HT9025-16-26	41.0	50.00	1"11BSPP	22.20	M26X1.5 6g	18.00
32	HT9025-16-30	41.0	50.00	1"11BSPP	22.20	M30X2.0 6g	21.00

ALL REQUIREMENT AS PER SAE J514/ BS:5200

ALL DIMENSIONS ARE IN MM



[www.HYTECHGROUP.com](http://www.HYTECHGROUP.com)

World class

Hydraulic Fittings, Cylinders, Hoses & Precision Components  
ISO 9001-2008 Company



## CONVERSION FITTINGS - HT9222-00-00

### CONVERSION FITTINGS -

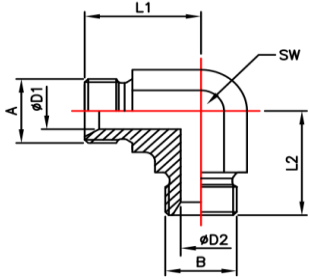

**MBSPP-MBSPP 90° Elbow**

SR. NO.	PART NO.	SW	A		ØD1	B		Ød2
			BSPP THREAD	L1		BSPP THREAD (INT)	L1	
01	HT9222-04-04	14.00	1/4"-19BSPP	26.00	4.70	1/4"-19BSPP	26.00	4.70
02	HT9222-06-04	19.00	3/8"-19BSPP	30.00	7.90	1/4"-19BSPP	27.80	4.70
03	HT9222-06-06	19.00	3/8"-19BSPP	30.00	7.90	3/8"-19BSPP	30.00	7.90
04	HT9222-08-06	22.00	1/2"-14BSPP	35.00	11.10	3/8"-19BSPP	34.00	7.90
05	HT9222-08-08	22.00	1/2"-14BSPP	35.00	11.10	1/2"-14BSPP	35.00	11.10
06	HT9222-10-10	24.00	5/8"-14BSPP	38.00	14.30	5/8"-14BSPP	38.00	14.30
07	HT9222-12-08	27.00	3/4"-14BSPP	42.00	16.70	1/2"-14BSPP	37.00	11.10
08	HT9222-12-10	27.00	3/4"-14BSPP	42.00	16.70	5/8"-14BSPP	40.00	14.30
09	HT9222-12-12	27.00	3/4"-14BSPP	42.00	16.70	3/4"-14BSPP	42.00	16.70
10	HT9222-16-12	33.00	1"-11BSPP	47.00	22.20	3/4"-14BSPP	46.00	16.70
11	HT9222-16-16	33.00	1"-11BSPP	47.00	22.20	1/2"-14BSPP	47.00	22.20

ALL REQUIREMENT AS PER ISO 8434-6 & BS:5200

ALL DIMENSIONS ARE IN MM



[www.HYTECHGROUP.com](http://www.HYTECHGROUP.com)

World class

Hydraulic Fittings, Cylinders, Hoses & Precision Components  
ISO 9001-2008 Company



## CONVERSION FITTINGS - HT9322-00-00

[CONVERSION FITTINGS -](#)

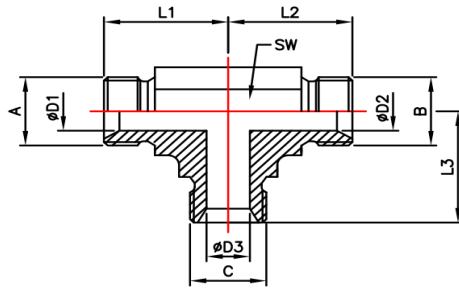

MBSPP TEE

SR. NO.	PART NO.	SW	A BSPP THREAD	L1	ØD1	B BSPP THREAD	L2	Ød2	C BSPP THREAD	L3	ØD3
01	HT9322-04-04-04	14.00	1/4"-19BSPP	26.00	4.70	1/4"-19BSPP	26.00	4.70	1/4"-19BSPP	26.00	4.70
02	HT9322-06-06-06	19.00	3/8"-19BSPP	30.00	7.90	3/8"-19BSPP	30.00	7.90	3/8"-19BSPP	30.00	7.90
03	HT9322-08-08-08	22.00	1/2"-14BSPP	35.00	11.10	1/2"-14BSPP	35.00	11.10	1/2"-14BSPP	35.00	11.10
04	HT9322-10-10-10	24.00	5/8"14BSPP	38.00	14.30	5/8"14BSPP	38.00	14.30	5/8"14BSPP	38.00	14.30
05	HT9322-12-12-12	27.00	3/4"-14BSPP	42.00	16.70	3/4"-14BSPP	42.00	16.70	3/4"-14BSPP	42.00	16.70
06	HT9322-16-16-16	33.00	1"-11BSPP	47.00	22.20	1"-11BSPP	47.00	22.20	1"-11BSPP	47.00	22.20

ALL REQUIREMENT AS PER ISO 8434-6

ALL DIMENSIONS ARE IN MM



[www.HYTECHGROUP.com](http://www.HYTECHGROUP.com)

World class

Hydraulic Fittings, Cylinders, Hoses & Precision Components  
ISO 9001-2008 Company



## CONVERSION FITTINGS - HT9500-P-00

### CONVERSION FITTINGS -

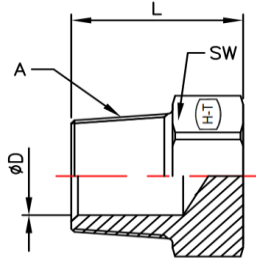

### MBSPT PLUG

SR. NO.	PART NO.	SW	BSPT THREAD	L	ØD
01	HT9500-P-02	11.0	1/8"-28BSPT	15.80	4.90
02	HT9500-P-04	14.0	1/4"-19BSPT	21.10	7.00
03	HT9500-P-06	19.0	3/8"-19BSPT	21.10	10.30
04	HT9500-P-08	22.0	1/2"-14BSPT	27.40	13.50
05	HT9500-P-12	27.0	3/4"-14BSPT	29.20	18.00
06	HT9500-P-16	36.0	1"-11BSPT	34.10	23.80
07	HT9500-P-20	41.0	1-1/4"-11BSPT	36.80	31.70
08	HT9500-P-24	50.0	1-1/2"-11BSPT	39.40	38.00

ALL REQUIREMENT AS PER ISO 9974-4

ALL DIMENSIONS ARE IN MM



[www.HYTECHGROUP.com](http://www.HYTECHGROUP.com)

World class

Hydraulic Fittings, Cylinders, Hoses & Precision Components  
ISO 9001-2008 Company



## CONVERSION FITTINGS - HT9522-H00-O

[CONVERSION FITTINGS -](#)

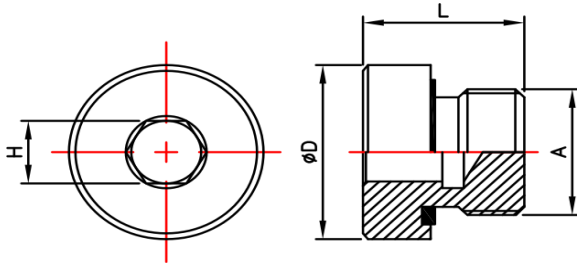

**MBSPP-Hollow Hex Plug**

SR. NO.	PART NO.	ØD	L	A THREAD BSPP	H
01	HT9522-H02-O	14.0	12.00	1/8"-28BSPP	5.00
02	HT9522-H04-O	19.0	17.00	1/4"-19BSPP	6.00
03	HT9522-H06-O	22.0	17.00	3/8"-19BSPP	8.00
04	HT9522-H08-O	27.0	19.00	1/2"-14BSPP	10.00
05	HT9522-H12-O	32.0	21.00	3/4"-14BSPP	12.00
06	HT9522-H16-O	40.0	22.50	1"-11BSPP	17.00
07	HT9522-H20-O	50.0	22.50	1-1/4"-11BSPP	22.00
08	HT9522-H24-O	55.0	22.50	1-1/2"-11BSPP	24.00

ALL REQUIREMENT AS PER ISO8434

ALL DIMENSIONS ARE IN MM



[www.HYTECHGROUP.com](http://www.HYTECHGROUP.com)

World class

Hydraulic Fittings, Cylinders, Hoses & Precision Components  
ISO 9001-2008 Company



## CONVERSION FITTINGS - HT9522-P-00

CONVERSION FITTINGS -

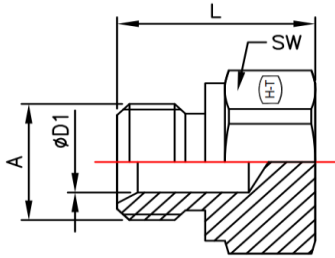

### MBSPP-Hex Plug

SR. NO.	PART NO.	SW	L	A THREAD BSPP	ØD1
01	HT9522-P-02	14.0	14.00	1/8"-28BSPP	3.50
02	HT9522-P-04	19.0	19.00	1/4"-19BSPP	4.70
03	HT9522-P-06	22.0	21.00	3/8"-19BSPP	7.90
04	HT9522-P-08	27.0	24.00	1/2"-14BSPP	11.10
05	HT9522-P-10	30.0	27.00	5/8"-14BSPP	14.30
06	HT9522-P-12	32.0	27.00	3/4"-14BSPP	16.70
07	HT9522-P-16	41.0	30.00	1"-11BSPP	22.20
08	HT9522-P-20	50.0	39.00	1-1/4"-11BSPP	28.60
09	HT9522-P-24	55.0	43.00	1-1/2"-11BSPP	33.30

ALL REQUIREMENT AS PER ISO8434

ALL DIMENSIONS ARE IN MM



[www.HYTECHGROUP.com](http://www.HYTECHGROUP.com)

World class

Hydraulic Fittings, Cylinders, Hoses & Precision Components  
ISO 9001-2008 Company



## CONVERSION FITTINGS - HT9644-C-00

### CONVERSION FITTINGS -

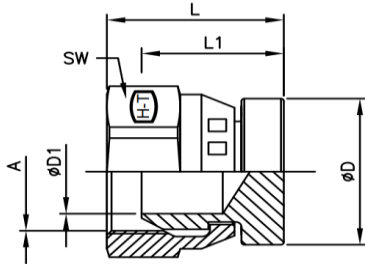

### FBSPP-CAP

SR. NO.	PART NO.	ØD	L	L1	A THREAD BSPP (INT)	ØD1	SW
01	HT9644-C-04	15.0	21.30	17.00	1/4"-19BSPP	4.7	19.0
02	HT9644-C-06	17.0	22.30	15.80	3/8"-19BSPP	7.9	22.0
03	HT9644-C-08	22.0	26.30	18.60	1/2"-14BSPP	11.1	27.0
04	HT9644-C-10	27.0	26.60	17.10	5/8"-14BSPP	14.3	30.0
05	HT9644-C-12	30.0	28.05	19.00	3/4"-14BSPP	16.7	32.0
06	HT9644-C-16	36.0	34.00	23.50	1"-11BSPP	22.2	41.0

ALL REQUIREMENT AS PER ISO8434

ALL DIMENSIONS ARE IN MM





[www.HYTECHGROUP.com](http://www.HYTECHGROUP.com)

World class

Hydraulic Fittings, Cylinders, Hoses & Precision Components  
ISO 9001-2008 Company



## CONVERSION FITTINGS - HT9722-00-00-LN

[CONVERSION FITTINGS -](#)

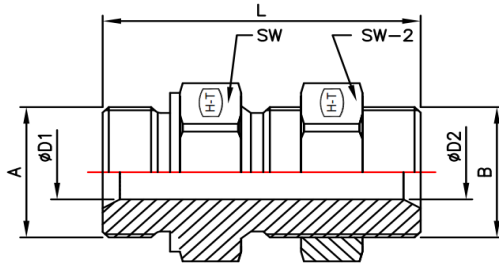

### MBSPP-MBSPP BHLN

S.R. NO.	PART NO.	SW	L	A BSPP THREAD	ØD1	B BSPT THREAD	ØD2	SW-2
01	HT9722-04-04-LN	19.0	46.00	1/4"-19BSPP	4.70	1/4"-19BSPP	4.70	19.0
02	HT9722-04-06-LN	22.0	51.00	1/4"-19BSPP	4.70	3/8"-19BSPP	7.90	22.0
03	HT9722-06-04-LN	22.0	48.00	3/8"-19BSPP	7.90	3/8"-19BSPP	7.90	22.0
04	HT9722-06-06-LN	22.0	52.00	3/8"-19BSPP	7.90	3/8"-19BSPP	7.90	22.0
05	HT9722-06-08-LN	27.0	57.00	3/8"-19BSPP	7.90	1/2"-14BSPP	11.10	27.0
06	HT9722-08-08-LN	27.0	59.00	1/2"-14BSPP	11.10	1/2"-14BSPP	11.10	27.0
07	HT9722-08-06-LN	27.0	56.00	1/2"-14BSPP	11.10	1/4"-19BSPP	4.70	27.0
08	HT9722-08-12-LN	32.0	64.00	1/2"-14BSPP	11.10	3/4"-14BSPP	16.70	32.0
09	HT9722-10-10-LN	30.0	63.00	5/8"-14BSPP	14.30	5/8"-14BSPP	14.30	30.0
10	HT9722-12-08-LN	32.0	63.00	3/4"-14BSPP	16.70	1/2"-14BSPP	11.10	32.0
11	HT9722-12-12-LN	32.0	66.00	3/4"-14BSPP	16.70	3/4"-14BSPP	16.70	32.0
12	HT9722-12-16-LN	41.0	72.00	3/4"-14BSPP	16.70	1"-11BSPP	22.20	41.0
13	HT9722-16-16-LN	41.0	75.00	1"-11BSPP	22.20	1"-11BSPP	22.20	41.0

ALL REQUIREMENT AS PER BS:5200 / ISO:8434

ALL DIMENSIONS ARE IN MM



[www.HYTECHGROUP.com](http://www.HYTECHGROUP.com)

World class

Hydraulic Fittings, Cylinders, Hoses & Precision Components  
ISO 9001-2008 Company



## CONVERSION FITTINGS - HT9900-00

[CONVERSION FITTINGS -](#)

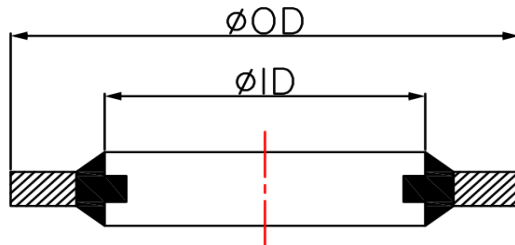

### Self Centering Bonded Seal BSPP

SR. NO.	PART NO.	PART DESCRIPTION	ID	OD
01	HT9900-02	1/8"BSPP SELF CENTERING BONDED SEAL	10.37	15.88
02	HT9900-04	1/4"BSPP SELF CENTERING BONDED SEAL	13.74	20.57
03	HT9900-06	3/8"BSPP SELF CENTERING BONDED SEAL	17.28	23.80
04	HT9900-08	1/2"BSPP SELF CENTERING BONDED SEAL	21.54	28.58
05	HT9900-10	5/8"BSPP SELF CENTERING BONDED SEAL	23.49	31.75
06	HT9900-12	3/4"BSPP SELF CENTERING BONDED SEAL	27.05	34.93
07	HT9900-14	7/8"BSPP SELF CENTERING BONDED SEAL	30.81	38.10
08	HT9900-16	1"BSPP SELF CENTERING BONDED SEAL	33.89	42.80
09	HT9900-20	1-1/4"BSPP SELF CENTERING BONDED SEAL	42.93	52.38
10	HT9900-24	1-1/2"BSPP SELF CENTERING BONDED SEAL	48.44	58.60
11	HT9900-30	2"BSPP SELF CENTERING BONDED SEAL	60.58	73.03

ALL REQUIREMENT AS PER SAE J514 & BS:5200

ALL DIMENSIONS ARE IN MM



[www.HYTECHGROUP.com](http://www.HYTECHGROUP.com)

World class

Hydraulic Fittings, Cylinders, Hoses & Precision Components  
ISO 9001-2008 Company



## CONVERSION FITTINGS - HT9925-00

[CONVERSION FITTINGS -](#)

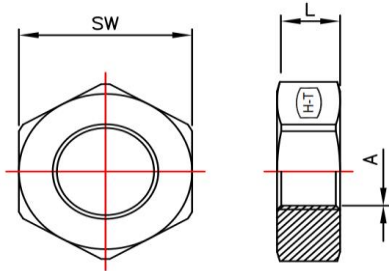

### BSPP BH LOCK NUT

SR. NO.	PART NO.	SW	L	A THREAD BSPP (INT)
01	HT9925-02	14.0	5.00	1/8"-28BSPP
02	HT9925-04	19.0	6.00	1/4"-19BSPP
03	HT9925-06	22.0	7.00	3/8"-19BSPP
04	HT9925-08	27.0	8.00	1/2"-14BSPP
05	HT9925-10	30.0	9.00	5/8"-14BSPP
06	HT9925-12	32.0	9.00	3/4"-14BSPP
07	HT9925-16	41.0	10.00	1-11"BSPP
08	HT9925-20	50.0	13.00	1-1/4"-11BSPP
09	HT9925-24	55.0	15.00	1-1/2"-11BSPP
10	HT9925-32	70.0	15.00	2"-11BSPP

ALL REQUIREMENT AS PER SAE J514 & BS:5200

ALL DIMENSIONS ARE IN MM